

P R E M I U M S T A I R P A R T S C O L L E C T I O N

WM Coffman®

STAIR PARTS BUYER'S GUIDE

Gather Inspiration. Design with Dramatic Flair. Create a Unique Masterpiece.

It's easy to do with WM Coffman's Stair Parts Collection. As you will see, no matter what your style, we will help you achieve a natural warmth with your staircase.

We have focused our passion for excellence in design and craftsmanship to produce a series of Hardwood Collections that offer you a varied palette to create the style, scale and look that is right for any room or foyer. Select your personal preference from a broad array of designs that range from the influential Georgian, Federal and Chippendale styles to Contemporary looks that easily adapt to any décor.

Each collection and profile can be combined with our Iron Collection and Box Newel Collection to create a truly unique look. And, with the ability to give your staircase a personal touch with the wood specie of your choice, your design possibilities become almost endless.



<i>SECTION</i>	<i>PAGE NUMBER</i>
Iron Balustrade Collection	3-10
Box Newel Collection	11-13
Traditional Collection	14-15
Classic Collection	16-17
Bristol Collection	18
Marion Collection	19
Chippendale Collection	20
Art Deco Collection	21
Richmond Collection	22
Hampton Collection	23
Craftsman Collection	24
Wall Rails, Brackets, Rosettes	25
Fittings	26-27
Starting Steps	28
Treads and Risers	29
Hardware and Accessories	30
Index	31

All WM Coffman products are for Interior Use Only.





IRON FINISHES



BLK
FLAT BLACK

SAT
SATIN BLACK

PC
GRAY/BLACK

ABZ
ANTIQU BRONZE

Create a Dramatic and Inviting Stairway

Iron's exquisite appeal harkens back to earlier times of old world elegance while perfectly blending with today's modern architectural styles.

- Design possibilities are endless with the dozens of profiles available in WM Coffman's Woodmark Iron Collection.
- Each profile is offered in a single length, creating a trim from the bottom application. With profiles centered from the top of the baluster, the pattern you choose will always align with the angle of your stair.
- Incorporate 1, 2, 3 or more balusters for a truly unique look. Symmetry and elegance are guaranteed.
- Balusters are designed with a round top pin for easy and aesthetic installations (*exceptions are noted*).
- A full line of accessories and installation adhesive systems add decorative detail while providing secure installations.



ORC
OIL RUBBED COPPER

ORB
OIL RUBBED BRONZE

AN
ANTIQU NICKEL

IRON Construction Options

SOLID



A traditional FORGED construction.

LITE IRON



WM Coffman's industry leading HOLLOW CORE design reduces weight while maintaining strength.

Mediterranean

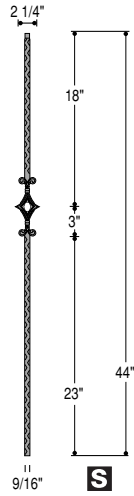

2760
M133
No AN

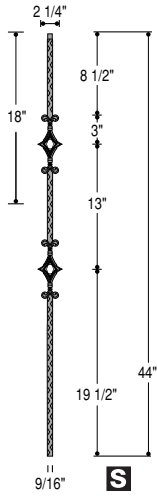

2761
M134
No AN

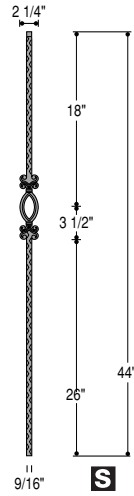

2762
M136
No AN

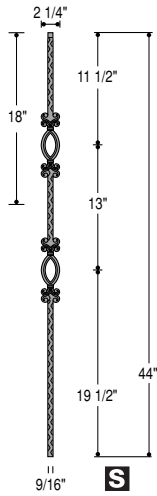

2763
M137
No AN

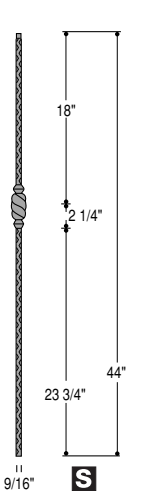

2766
M131
No AN

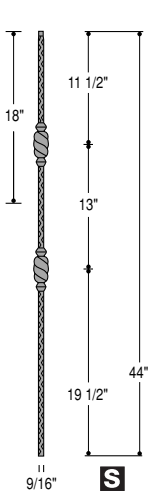

2767
M132
No AN

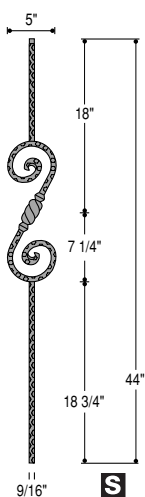

2768
M330
No AN

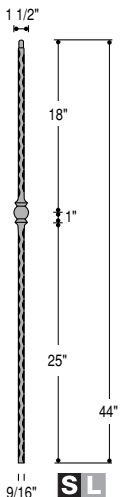

2990
M305
All Finishes

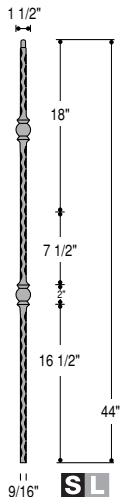

2991
M308
All Finishes

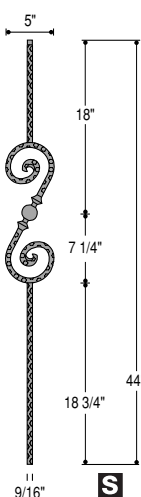

2792
M310
No AN

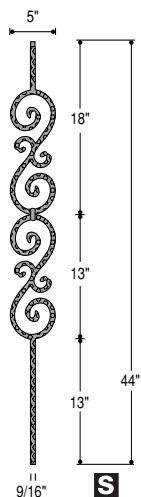

2796
M309
No AN

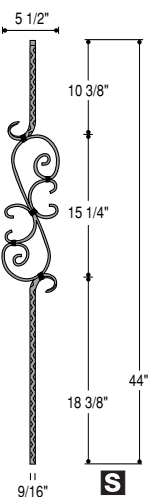

2797
M303
No AN

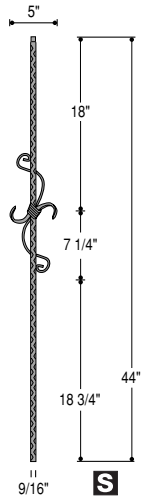

2798
M135
No AN

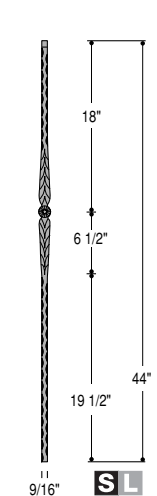

2996
Front View
M100
All Finishes

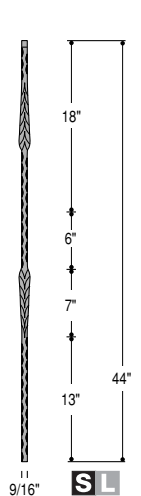

2997
Front View
M110
All Finishes

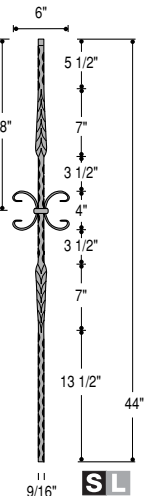

2998
Front View
M120
All Finishes (No AN - Solid)

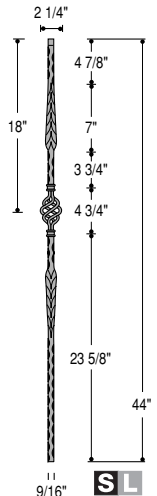

2999
Front View
M130
All Finishes

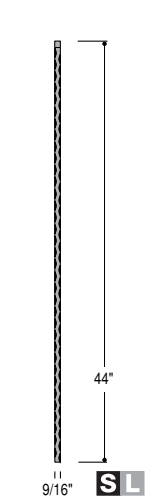

2995
M90
All Finishes

Venetian 5/8" Round



Shown: Detail 2598 Baluster

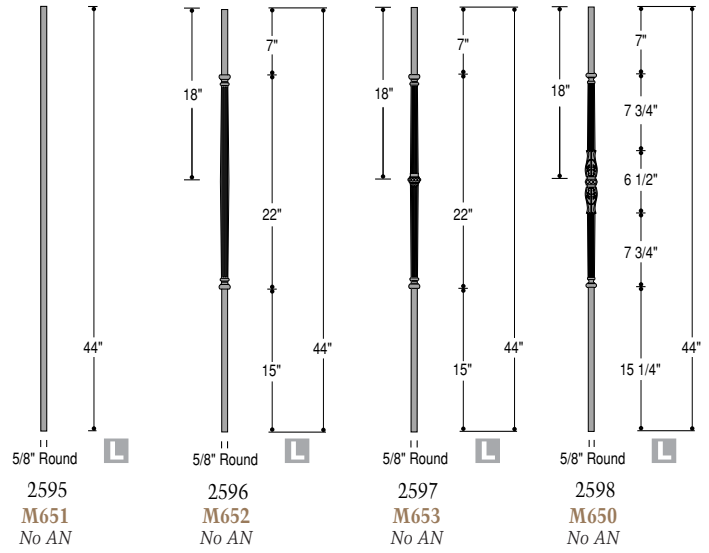

Round 1/2"

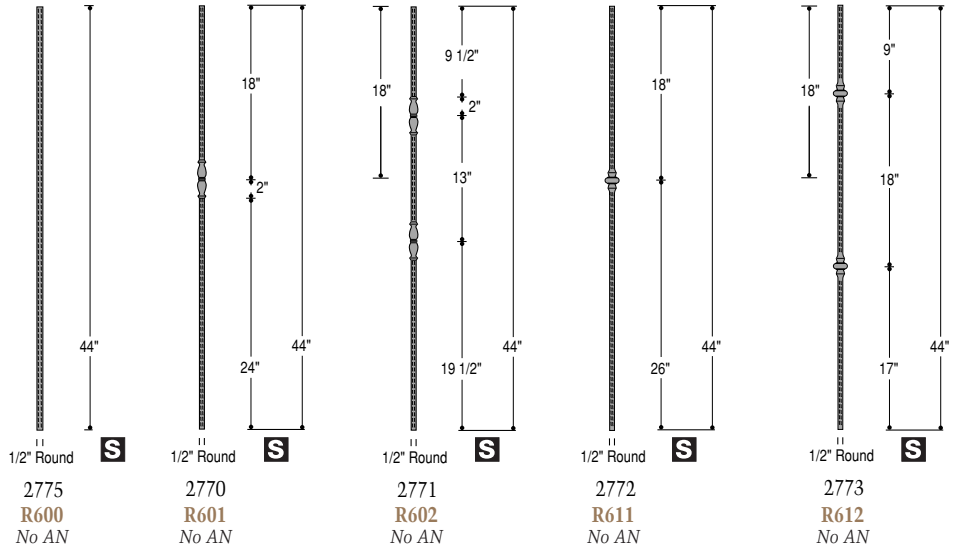

Round 9/16"

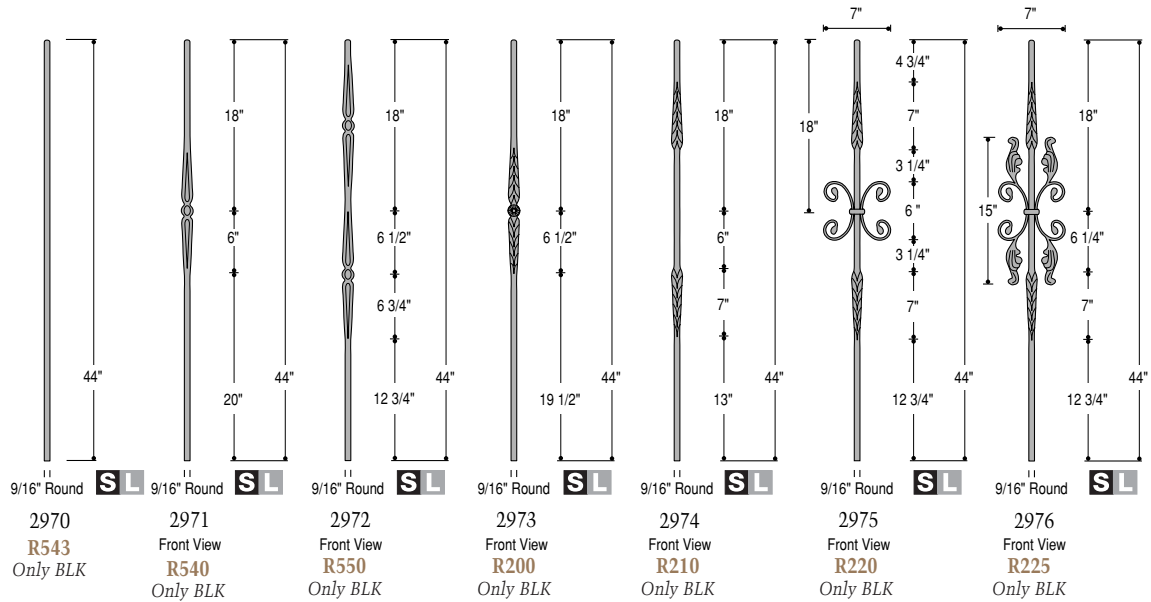

S Legend: SOLID IRON

L Legend: LITE IRON

Twist & Basket

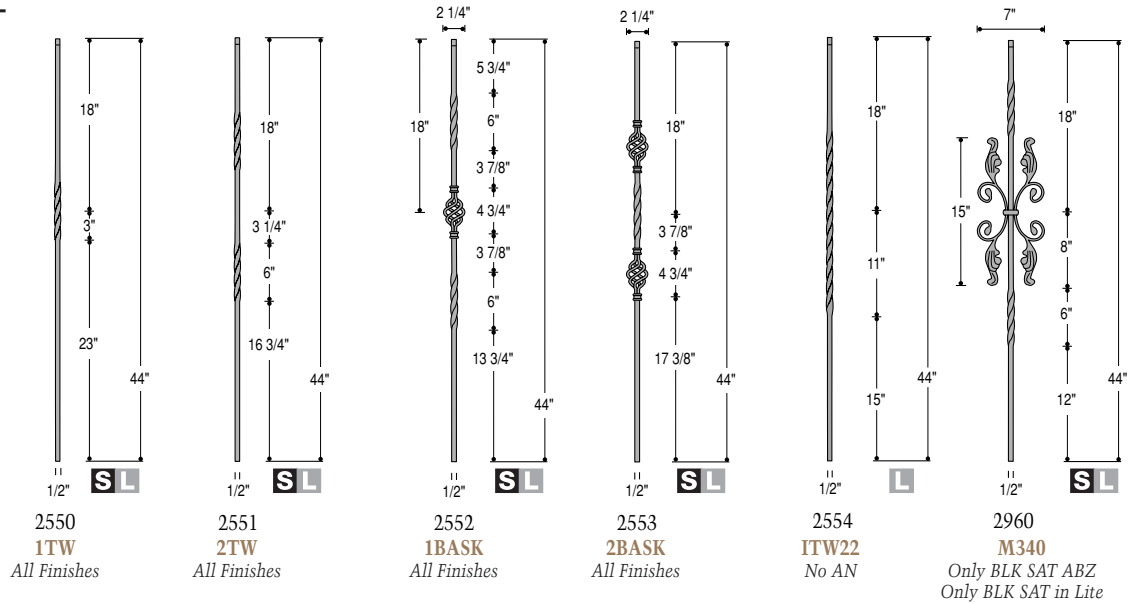

Versatile

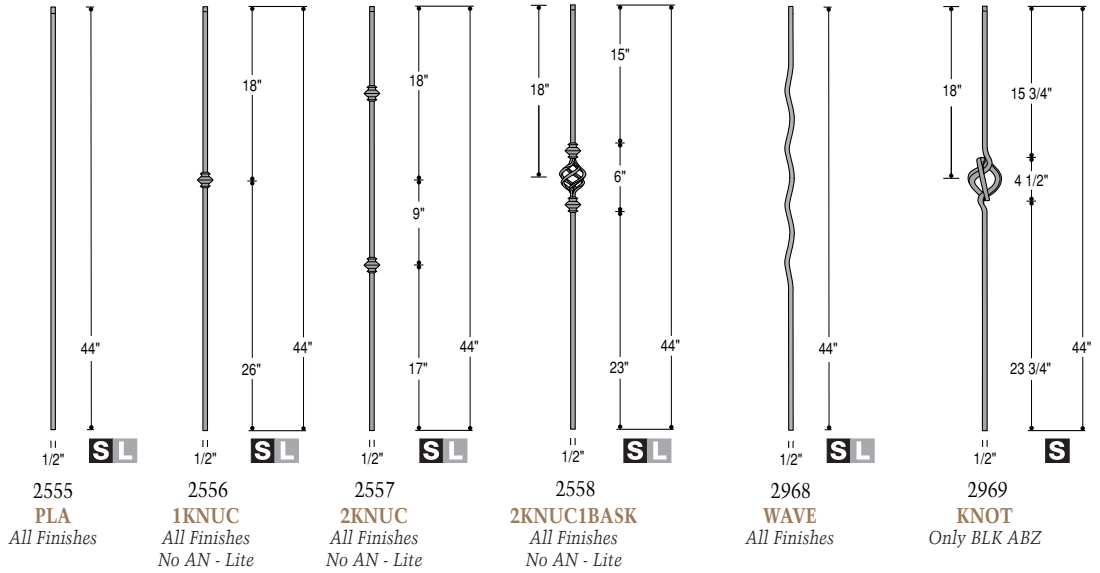

Ribbon

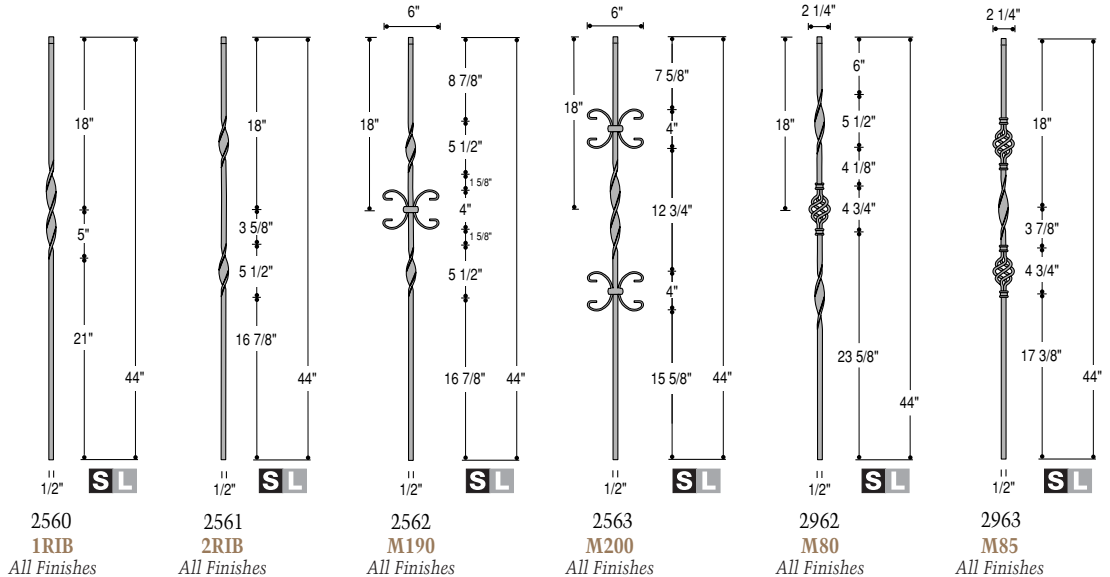

Gothic

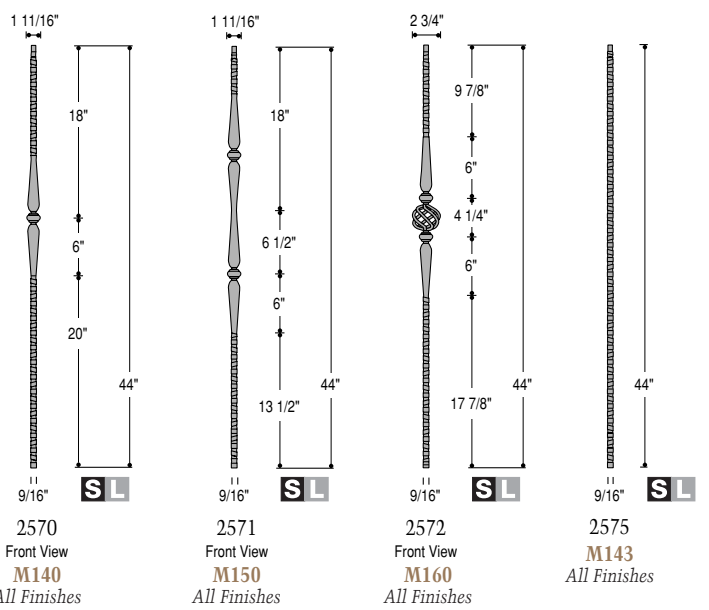

Scroll

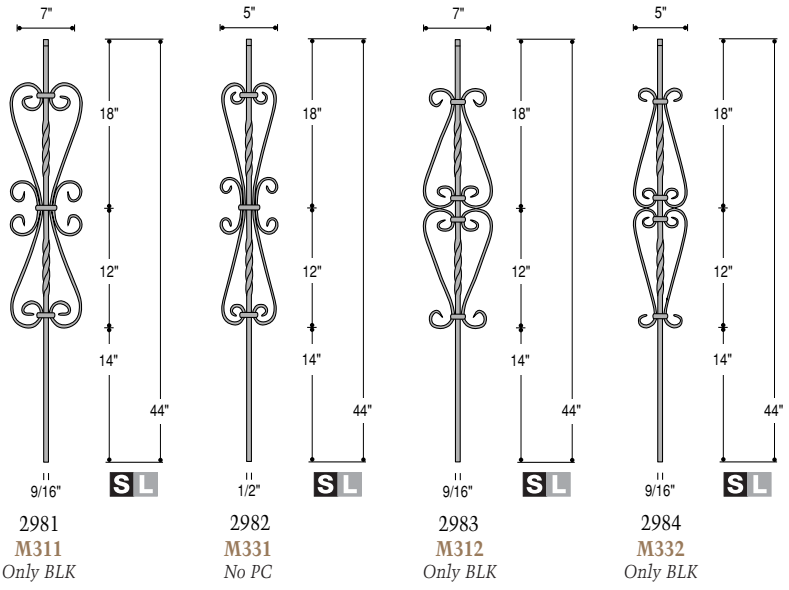
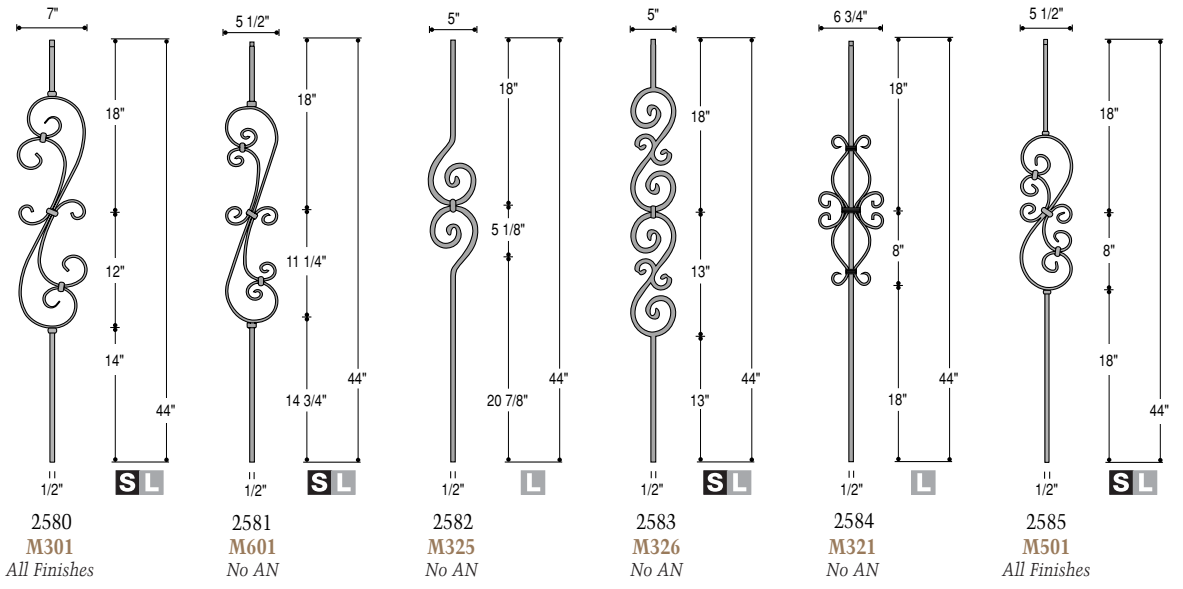

S Legend: SOLID IRON **L** Legend: LITE IRON

Medallion

4" Medallions for use in Medallion Balusters



2920
ME03
Only BLK



2921
US05
Only BLK



2922
ME08
Only BLK



2920
ME07
Only BLK



2924
ME07PB
Only BRASS Finish

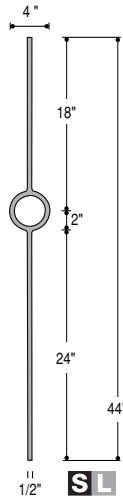

2930
M401
Only BLK

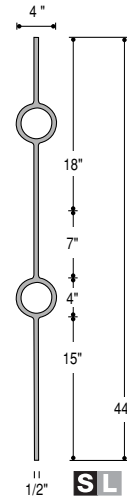

2931
M402
Only BLK

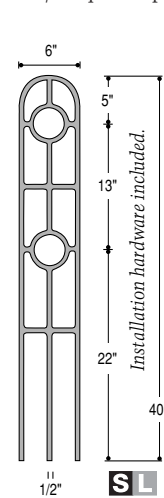

2932
M408
Only BLK

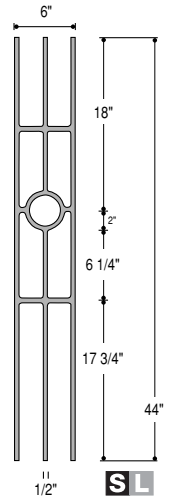

2933
M411
Only BLK

Mega

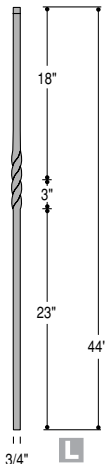

2850
MEGA-1TW
No AN

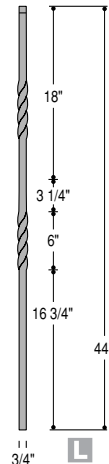

2851
MEGA-2TW
No AN

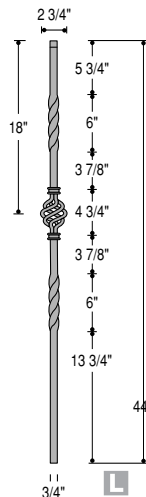

2852
MEGA-1BASK
No AN

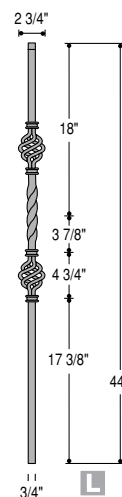

2853
MEGA-2BASK
No AN

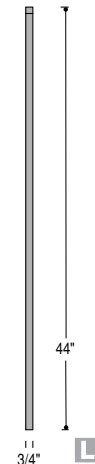

2855
MEGA-PLA
No AN

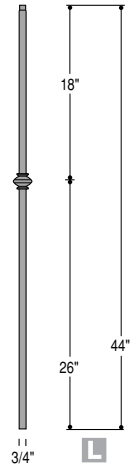

2856
MEGA-1KNUC
No AN

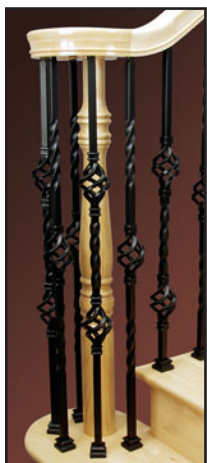

Shown: 2852 Baluster,
2853 Baluster,
2392 Flat Shoe.

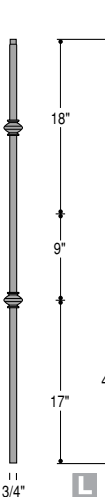

2857
MEGA-2KNUC
No AN

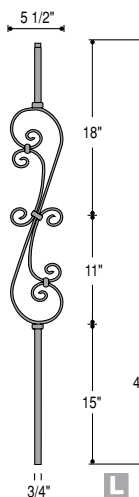

2881
MEGA-601
No AN

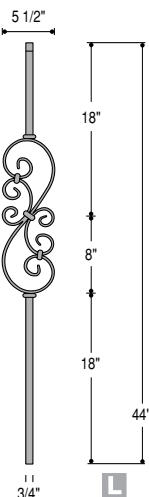

2885
MEGA-501
No AN

Belly

Belly Balusters have 1/2" square tops.

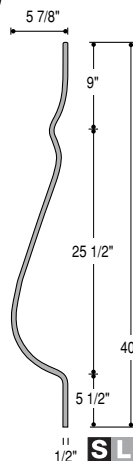

2986
PLA40-BLY
No AN

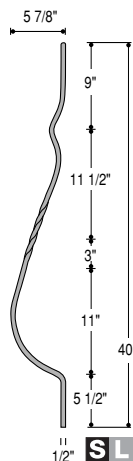

2987
ITW40-BLY
No AN

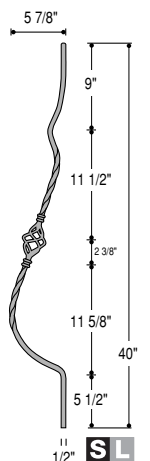

2988
1BASK40-BLY
No AN

Knee Wall



Shown: 2685 Knee Wall Scroll, 2555 Baluster, 2350 Rake Collar.

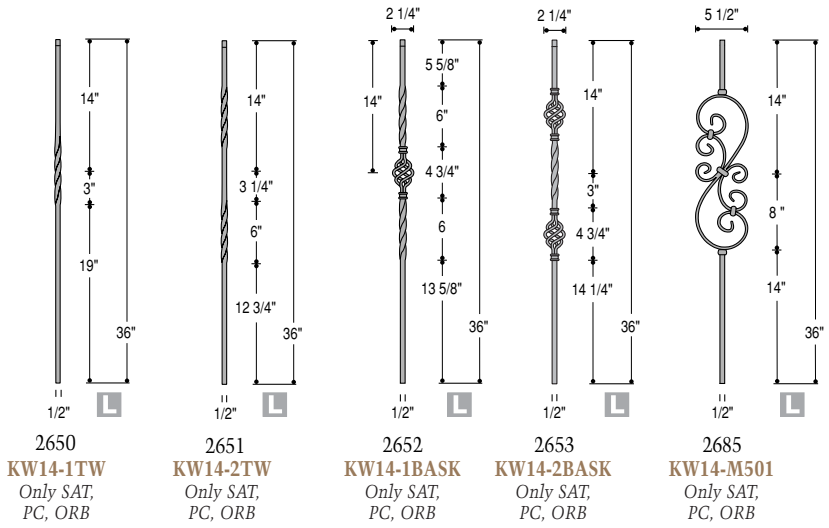

Decorative Panel

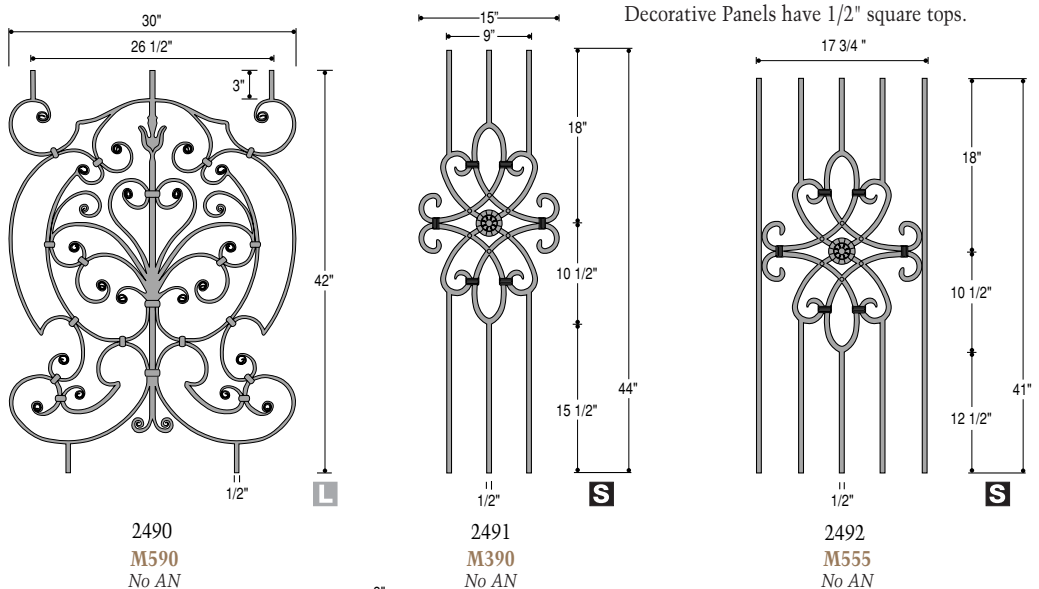

S Legend:
SOLID IRON

L Legend:
LITE IRON

Newels



Shown: Detail 2450 Newel

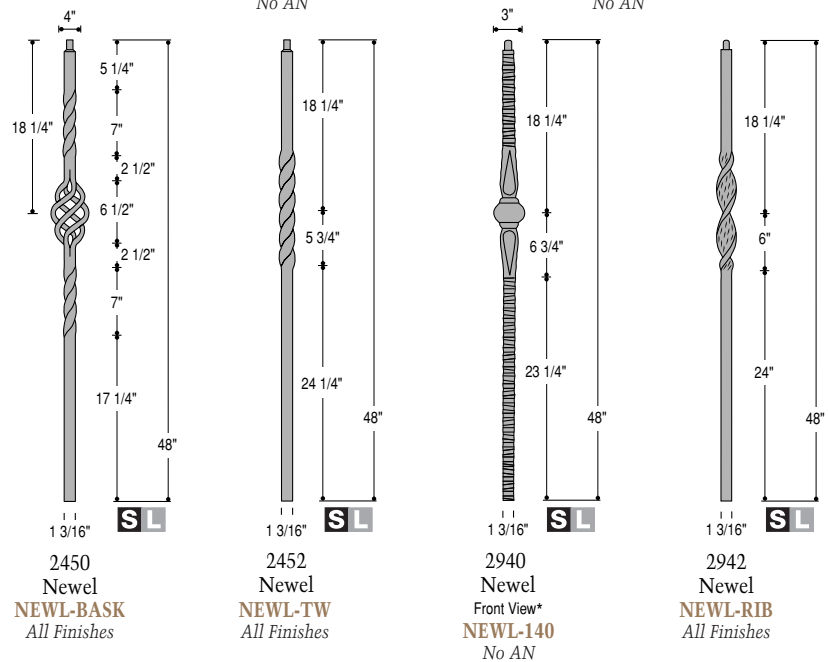

4091-KIT
Iron Panel and Cap Kit
All Finishes
Use with C-4091-IP
Box Newel
(See Page 11)

Shoe Options 1/2"



2340 **FSH01**
Flat Shoe
All Finishes

2342 **M06**
Tall Shoe
with Set Screw
All Finishes

2350 **PSH02**
Pitch Shoe
with Set Screw
All Finishes



2910 **SCR04**
Winged Shoe
All Finishes

2911 **M020**
Round Scalloped Shoe
No ORC, ORB, AN

2912 **M022**
Square Scalloped Shoe
Only BLK, PC

Shoe Options 9/16"



2341 **H03**
Flat Shoe
All Finishes

2351 **H05P**
Pitch Shoe
with Set Screw
All Finishes

2914 **H04**
Winged Shoe
All Finishes

2915 **H06**
Tall Shoe
with Set Screw
All Finishes

Adjustable Knuckle Options 1/2"

Adjustable Knuckles with Set Screw.



2345 **AK01**
Adj. Knuckle
All Finishes

2346 **AK02**
Fluted Barrel
All Finishes

2347 **AK03**
Urn
All Finishes

2348 **AK05**
Tall Barrel
All Finishes



2349 **AK04**
Fluted Deco
All Finishes

Universal Remodeling Shoes 1/2" and 9/16"



2330 **RM301**
Square Shoe
No AN

2331 **RM201**
Round Shoe
No AN

2332 **RM020**
Round Scalloped Shoe
No AN

Shoe Options 9/16" Dia.

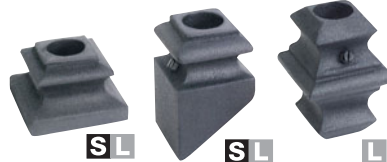

2916 **R07F**
Base Shoe
Only BLK

2917 **R06P**
Pitch Shoe
with Set Screw
Only BLK

2918 **RAK03**
Adj. Knuckle
with Set Screw
Only BLK

Shoe Options 1/2" Dia.



2370 **R08F**
Base Shoe
No AN

2371 **R09P**
Pitch Shoe
with Set Screw
No AN

MEGA Shoe Options 3/4"



2390 **MEGA-PSH08**
Pitch Shoe
with Set Screw
No AN

2391 **MEGA-FSH08**
Flat Shoe
No AN

2392 **MEGA-M08**
Flat Shoe
with Set Screw
No AN

2319 **MEGA-RD208**
Round Flat Shoe
No AN

2329 **MEGA-SQ308**
Square Flat Shoe
No AN

Shoe 5/8" Dia.



2375 **R10**
Round Shoe
5/8" Round Baluster
No AN

Universal Shoes 1/2" and 9/16"



2919 **RD201**
Round Flat Shoe
All Finishes



2333 **R05**
Round Flat Shoe
Black Polymer

Job-Lot Epoxy Adhesive System



2905 Adhesive Kit
5 oz. Adhesive
Cartridge and
Nozzle to be
used in standard
caulking gun.
(Approximately 50 balusters per tube. Open work time - 6 minutes.)

2906
Extra Nozzle for 2905



2901 **F-300**
11 oz. Epoxy
(Approximately 100 balusters per tube.
Open work time - 25 minutes)

2902 **F-101**
Injector Tool



EPOXY GLUE SYSTEM
2302 Manual Dispenser
2301 Adhesive (Approximately
20 balusters per tube.
Open work time - 25 minutes.)
2303 Mixing Nozzle (Packed 10 ea.)



2360 All parts
2362 Shoe only

2360 **NC101**
NEWEL ATTACHING SYSTEM
Base Collar, Shaft and Screws
All Finishes

2362
NEWL-FSH01
FLAT NEWEL SHOE — Only
All Finishes



Shown: C-4091 Box Newel, C-6210 P1 Handrail, C-5601 Balusters.

WM Coffman's Box Newel Collection offers you the ability to enhance the appearance of your stair with an impressive and bold style that blends with any of our rail and baluster profiles.

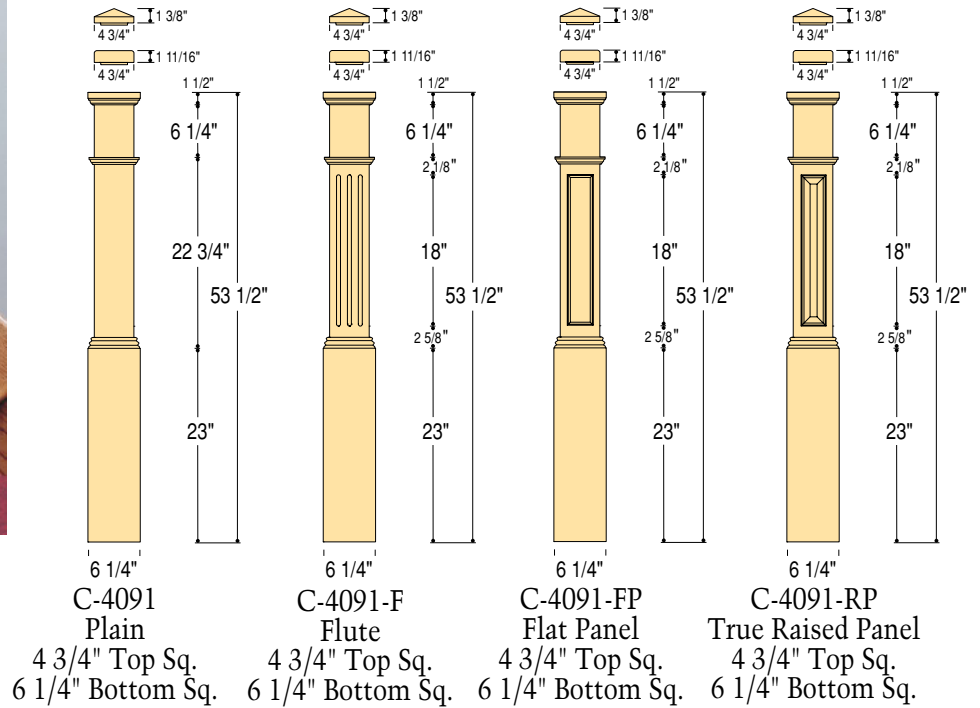

Shown: C-4091 Plain Box Newel



Shown: C-4091-F Fluted Box Newel

INTERCHANGEABLE BOX NEWEL CAPS

The Box Newels shown on this page are shipped with Interchangeable Flat and Peak Caps and have Hollow Top Construction which allows for secure handrail installation from inside the Box Newel.

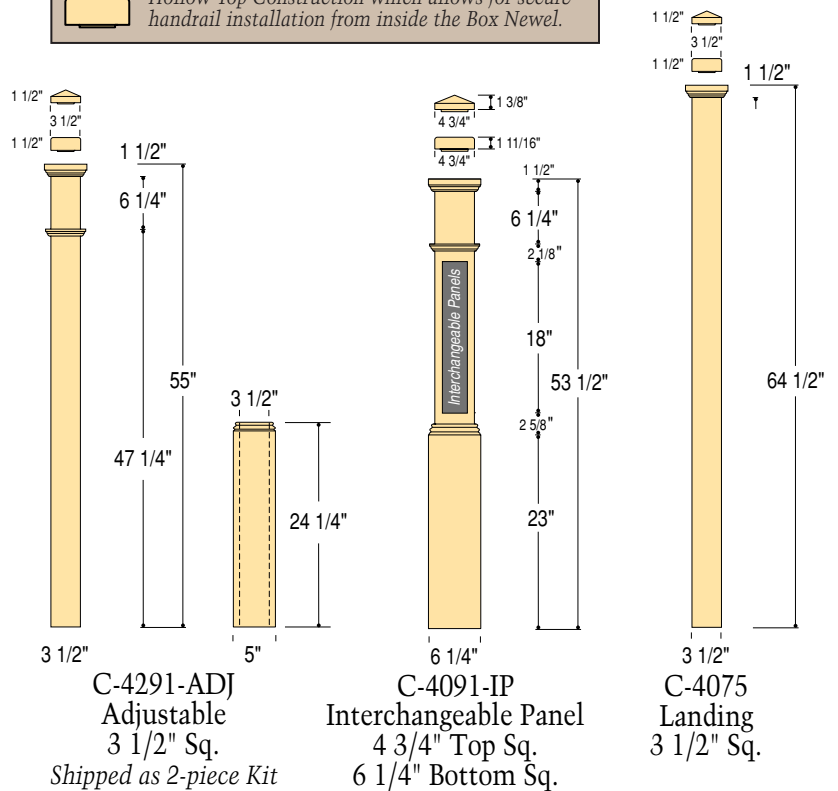

C-4291-ADJ
Adjustable
3 1/2" Sq.
Shipped as 2-piece Kit

C-4091-IP
Interchangeable Panel
4 3/4" Top Sq.
6 1/4" Bottom Sq.

C-4075
Landing
3 1/2" Sq.

Use with 4091-KIT
Iron Panel and Cap Kit (See Page 9)

BOX NEWELS



Shown: C-4095-F Fluted Box Newel, C-6110 Handrail, C-7112S Up Easing, C-5151 Balusters.

WM Coffman provides a complete selection of Box Newels offered with complementary sized Landing Newels to provide more design flexibility.

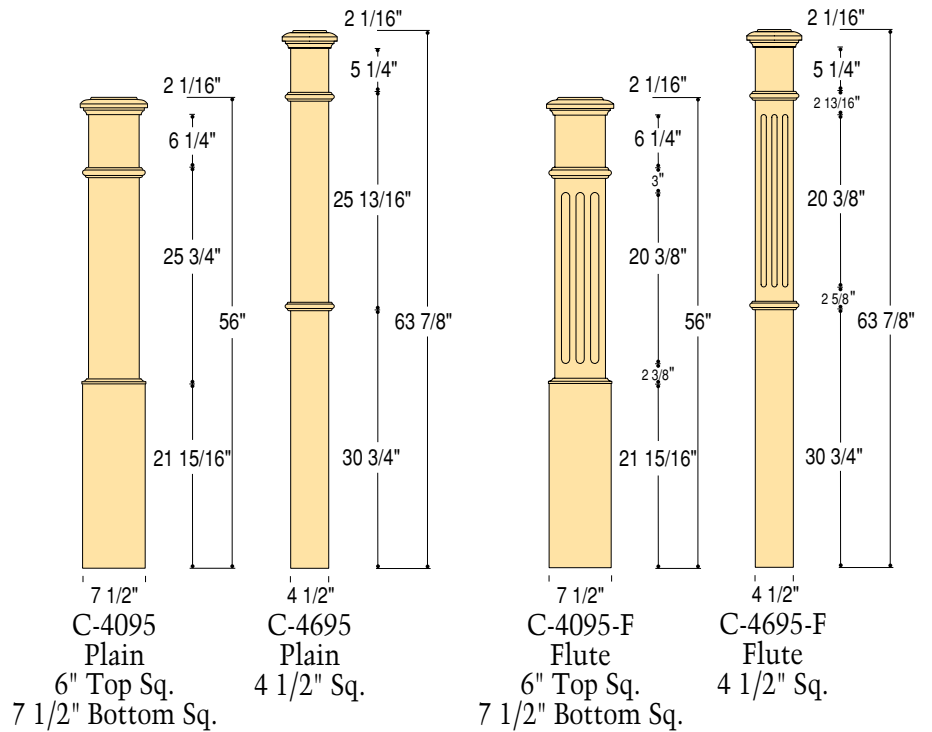

Shown: C-4095 Plain Box Newel

Shown: C-4695-RP Raised Panel Box Newel

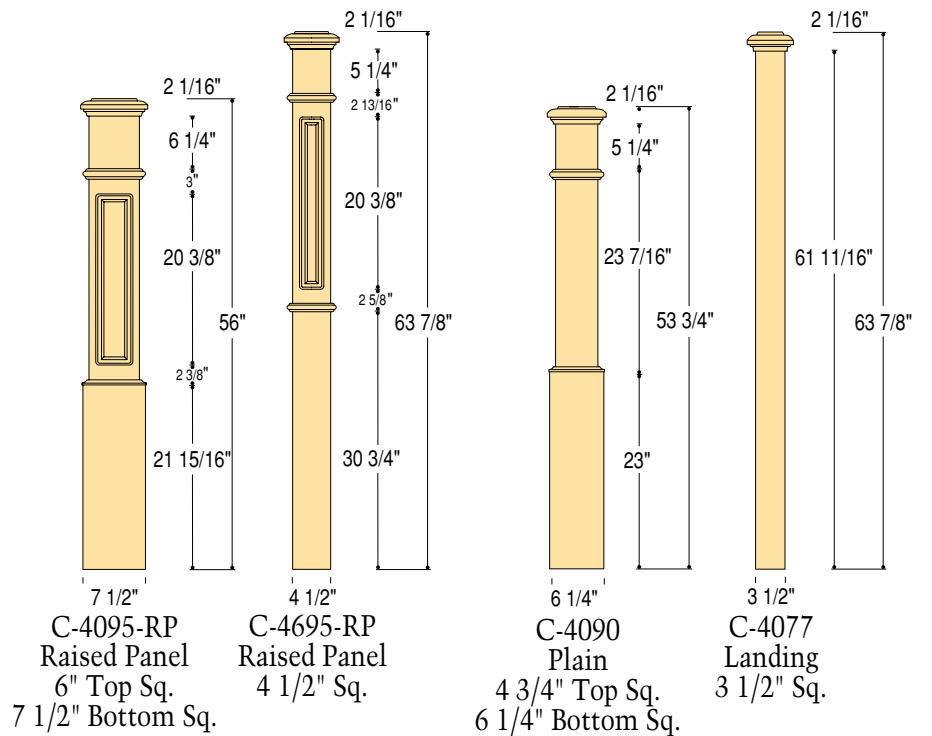



Shown: C-4891-FP Flat Panel Box Newel, C-6110 P1 Handrail, C-7112S Up Easing, C-5141 Balusters.

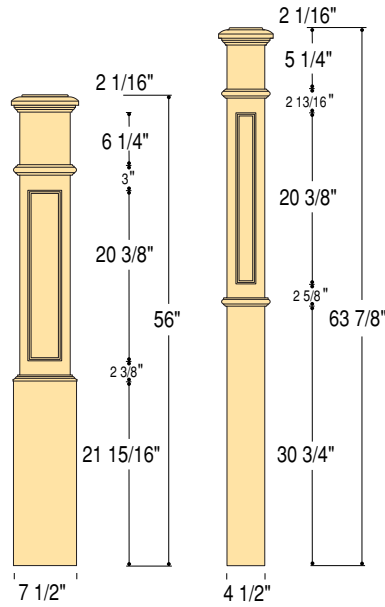

C-4891-FP
Flat Panel
6" Top Sq.
7 1/2" Bottom Sq.

C-4691-FP
Flat Panel
4 1/2" Sq.

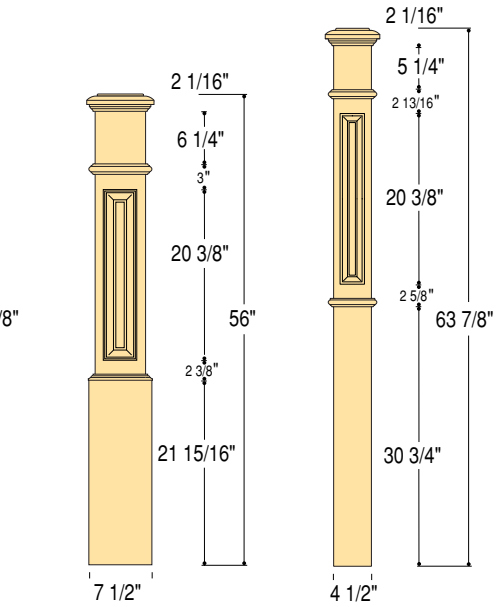

C-4891-RP
True Raised Panel
6" Top Sq.
7 1/2" Bottom Sq.

C-4691-RP
True Raised Panel
4 1/2" Sq.



Shown: C-4891-RP True Raised Panel Box Newel



Shown: C-4691-RP True Raised Panel Box Newel



Shown: C-4890 Mission Box Newel, C-6700 P1 Handrail, C-5360 Balusters.

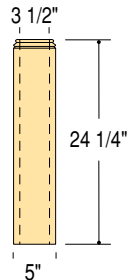

C-4099
Newel Sleeve - 3-1/2"
Mouldings Shipped Loose
(2 Profile Options - C-4091 and C-4095)



EZ MOUNT INSTALLATION SYSTEM

Exclusively from WM Coffman, the EZ Mount Base Block Installation System (includes block, 4 lag screws and washers) is included with all 6-1/4" and 7-1/2" Box Newels.

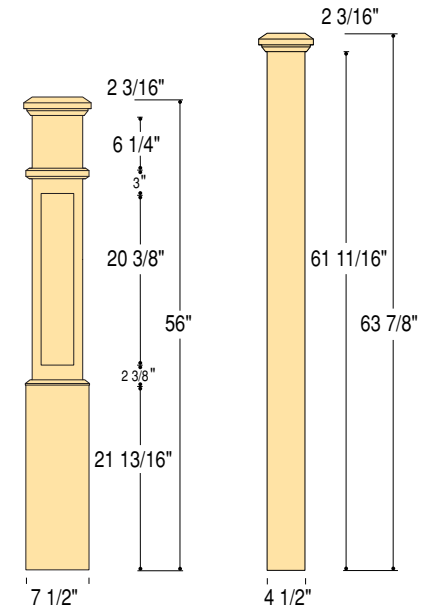

C-4890
Mission
6" Top Sq.
7 1/2" Bottom Sq.

C-4690
Mission
4 1/2" Sq.

TRADITIONAL OVER-THE-POST



C-6010

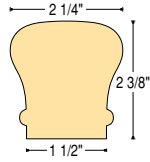

C-6010

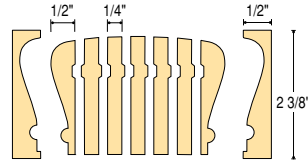

C-6016 (7 piece) Bending Rail with Bending Mould

Enlarged For Detail
All Long Block (LB)
balusters designed
and shipped with
removable pin.

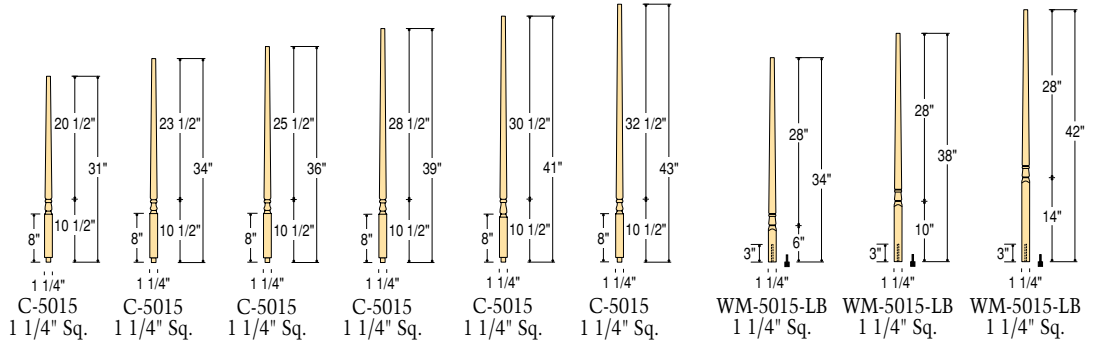
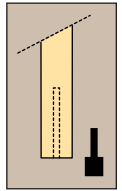

PR5015RP-34 PR5015RP-38 PR5015RP-42

Shown: C-6010 Handrail, C-5015 Balusters, C-4065 Starting Newel, C-7030 LH Volute, C-8010 Starting Step.

The Traditional Collection derives its beautiful style from the Georgian, Federal and Greek Revival periods of architecture. Graceful tapers and delicate beadwork are brought together to create a time-honored look.

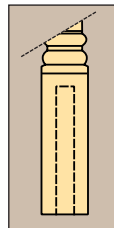
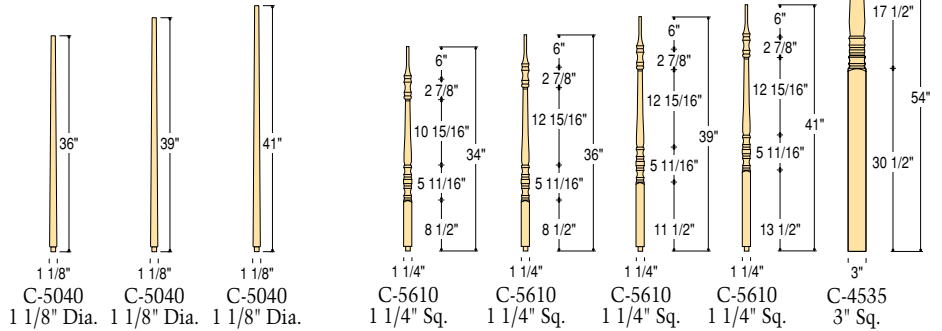

Enlarged For Detail
All Adjustable Newels
are bored and shipped
with loose dowel.

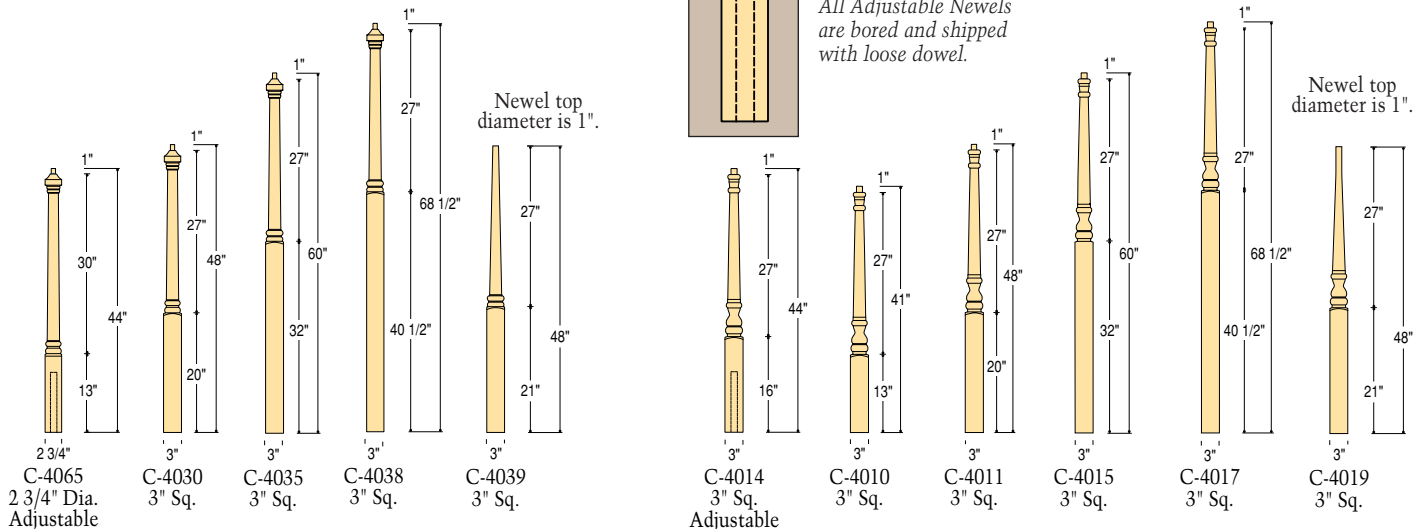

TRADITIONAL POST-TO-POST



C-6010 P
1 1/4" Plow

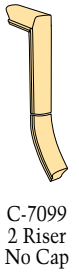
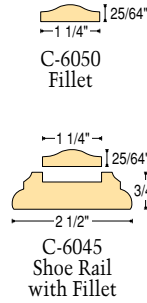
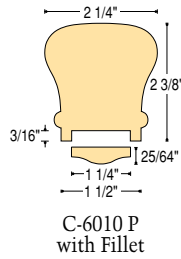

Shown: C-6010 P Handrail, C-5067
Balusters, C-4040 Starting Newel.



Newels at right are available
in 2 options.
For Ball Top specify (BT)

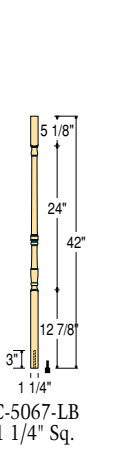
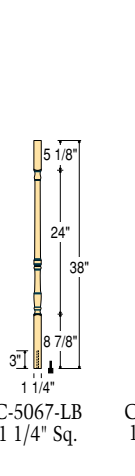
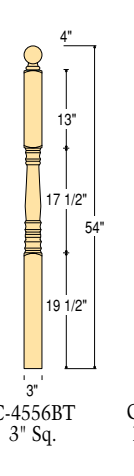
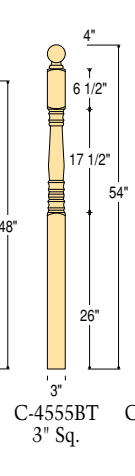
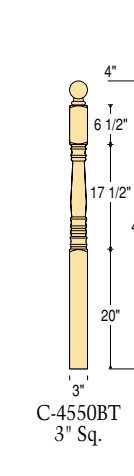
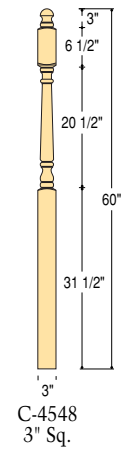
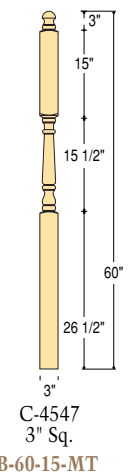
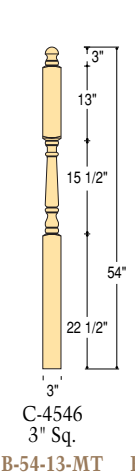
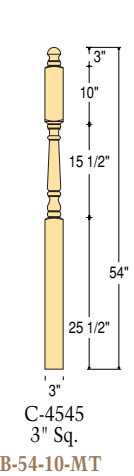
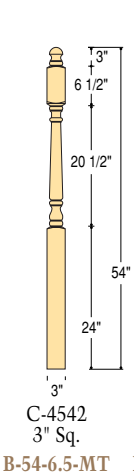
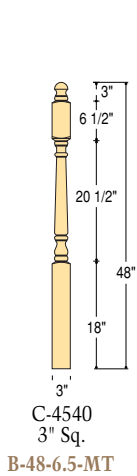
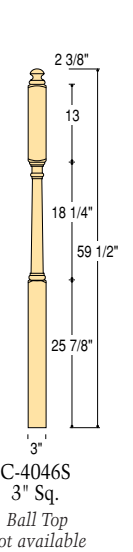
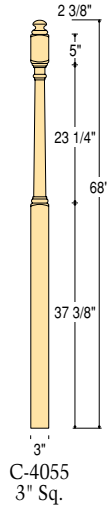
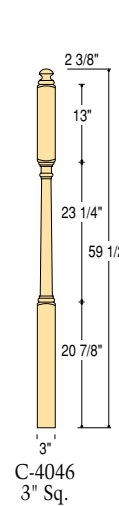
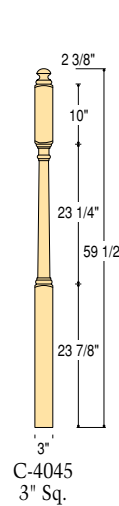
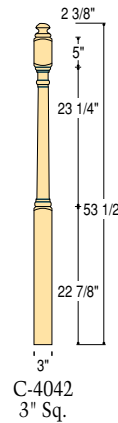
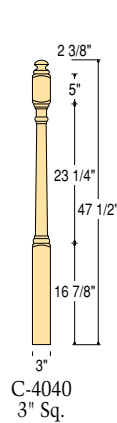

B-48-6.5-MT

B-54-6.5-MT

B-54-10-MT

B-54-13-MT

B-60-15-MT

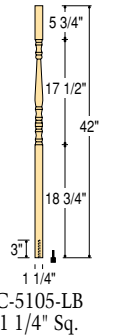
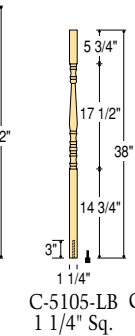
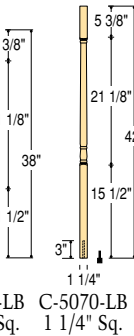
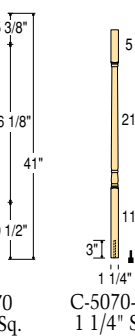
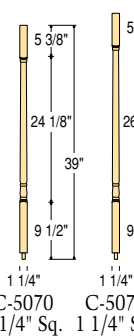
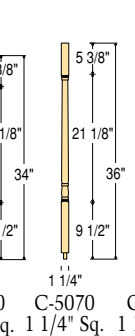
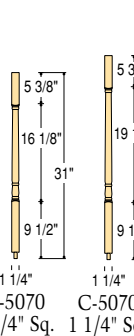
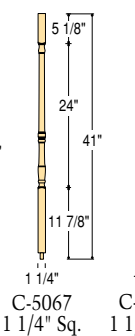
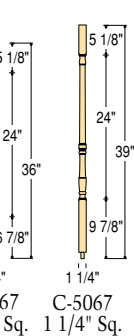
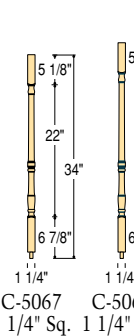
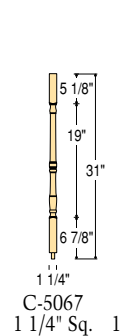

CLASSIC OVER-THE-POST



Inspired by the timeless appeal of Greek and Roman architecture, the **Classic Collection** is a blend of fine craftsmanship and purity of proportion. Balanced turnings accentuate an expertly carved urn, resulting in a profile recognized for its refined design.



C-6210

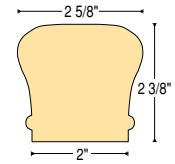

C-6210

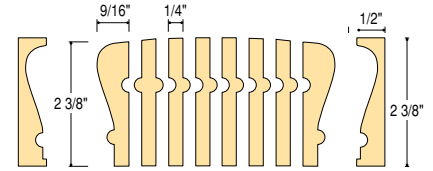

C-6216 Bending Rail with Bending Mould

Shown: C-6210 Handrail, C-5611 Balusters, C-4210 Starting Newel, C-7230 LH Volute, C-8010 Starting Step.

Enlarged For Detail
All Long Block (LB)
balusters designed
and shipped with
removable pin.

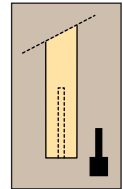

Shown: C-4662 Newel

Shown: C-4210 Newel

Shown: C-5611 Baluster

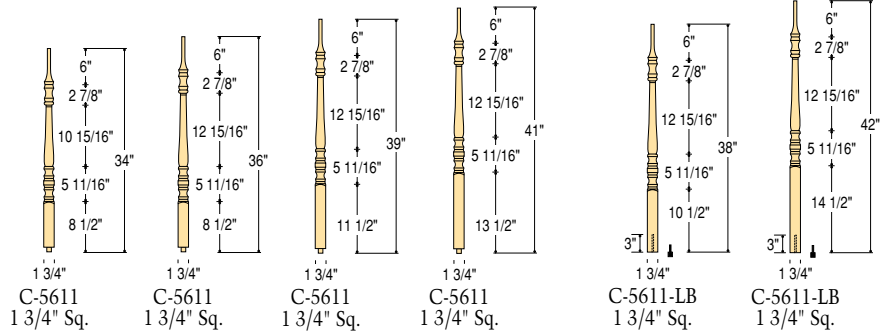

Newel top diameters are 2-1/8".

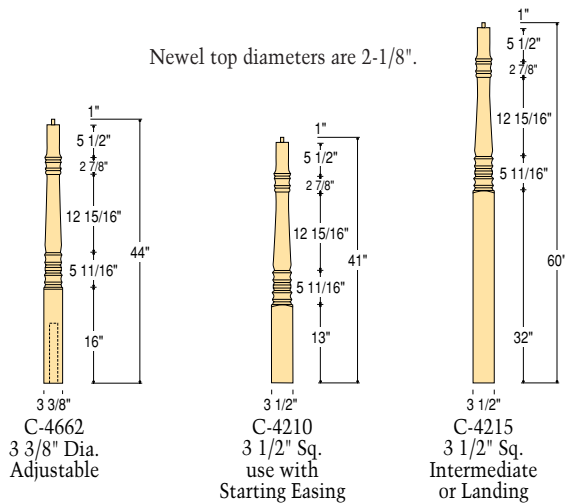

CLASSIC POST-TO-POST



C-6210 P1
1 3/4" Plow

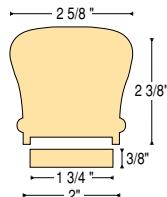

C-6210 P1
with Fillet

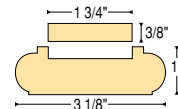

C-6006
Shoe Rail
with Fillet

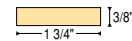

C-6007
Fillet

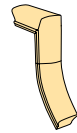

C-7298
1 Riser
No Cap

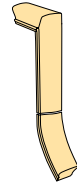

C-7299
2 Riser
No Cap

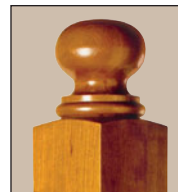

Newel Top Detail

Shown: C-6210 P1 Handrail, C-5601 Balusters,
C-4240 Starting Newel.

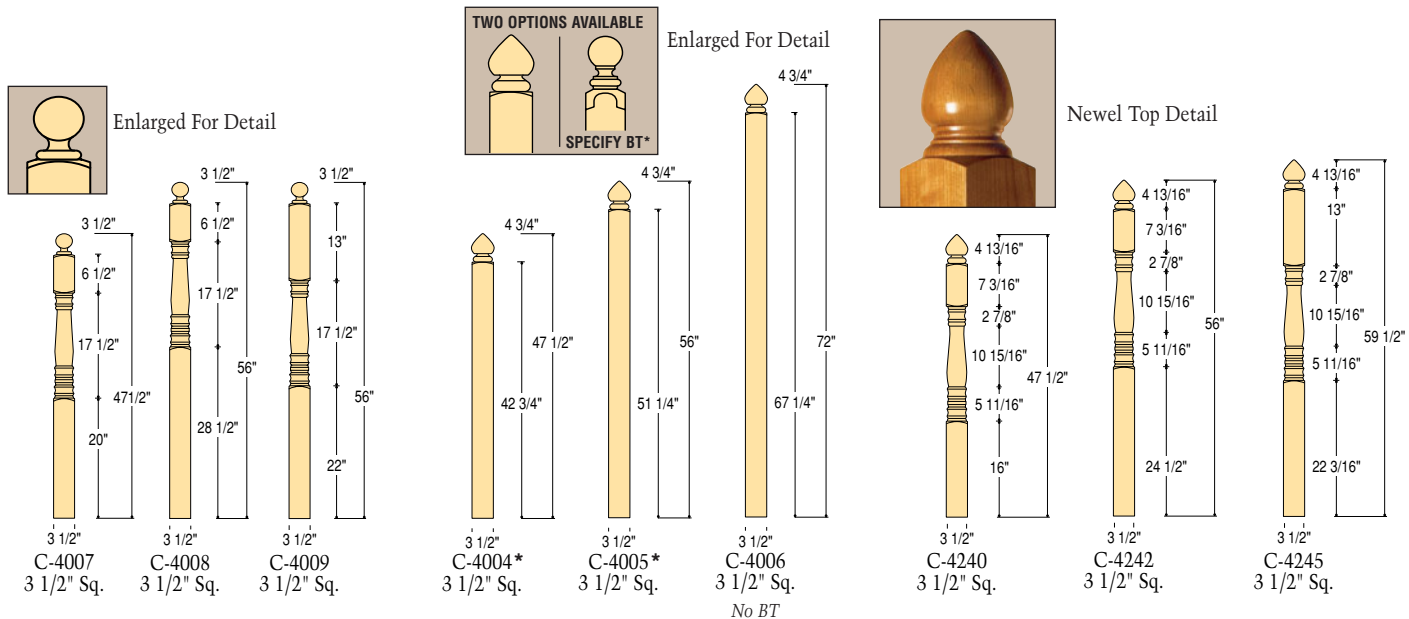
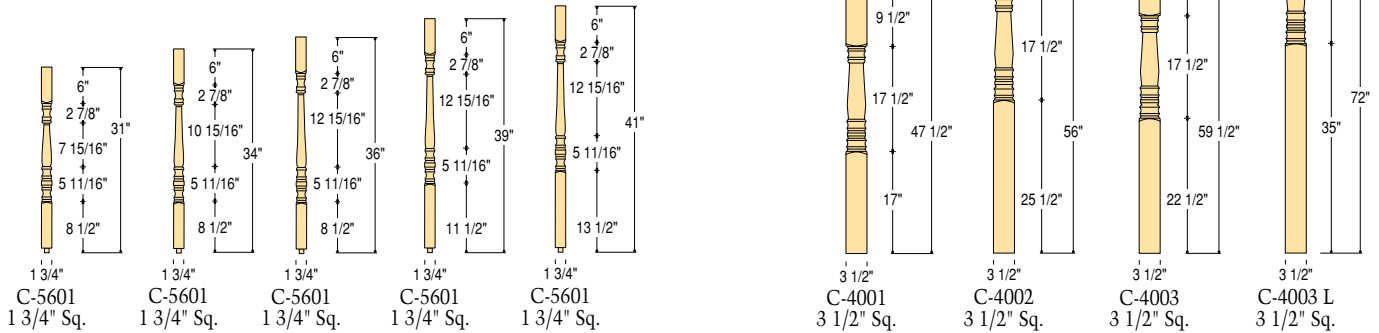

BRISTOL OVER-THE-POST



C-6110

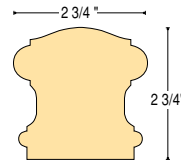

C-6110

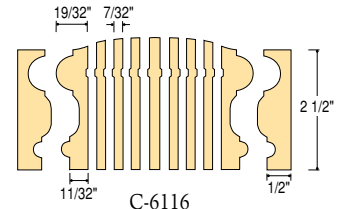

C-6116 Bending Rail with Bending Mould

Elegant detailing and simple design gives the Bristol Collection tremendous versatility. Balusters and newels feature a handsome vase.

Shown: C-6116 Bending Rail, C-5151 Balusters, C-4162 Starting Newel, C-7130 LH Volute, C-7135 RH Volute.

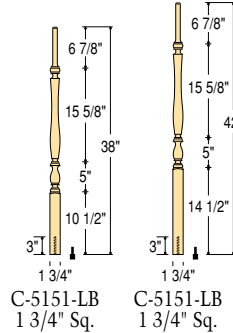
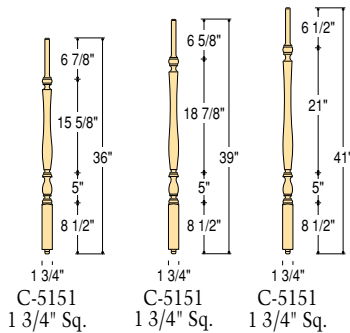

Enlarged For Detail All Long Block (LB) balusters designed and shipped with removable pin.

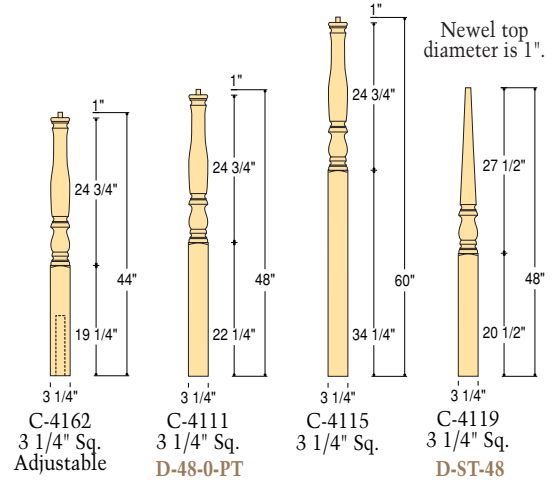
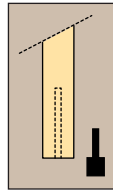

BRISTOL POST-TO-POST



C-6110 P1 1 3/4" Plow

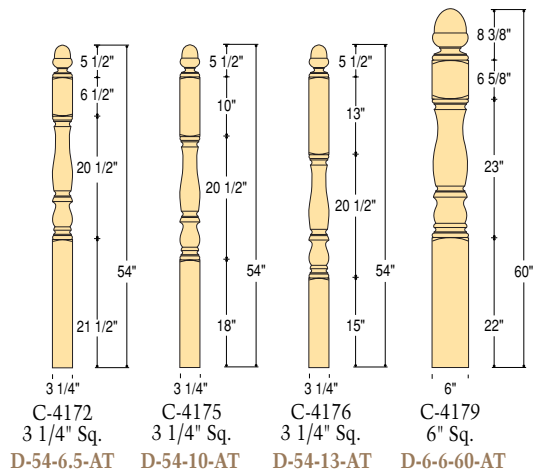
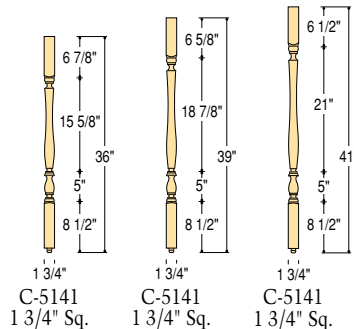
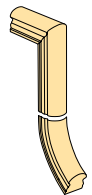
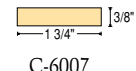
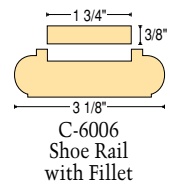
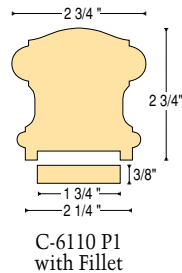

Shown: C-6110 P1 Handrail, C-5141 Balusters, C-4172 Starting Newel.

MARION OVER-THE-POST



C-6719

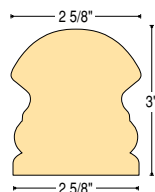

C-6719

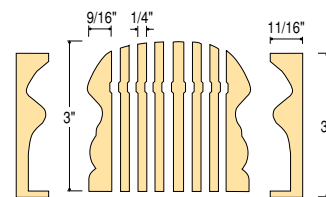

C-6716
Bending Rail with Bending Mould

The Marion Collection provides a versatile look that easily adapts to any setting. Urns, vases and transitional carvings combine to create strong lines that enhance any home's decor.

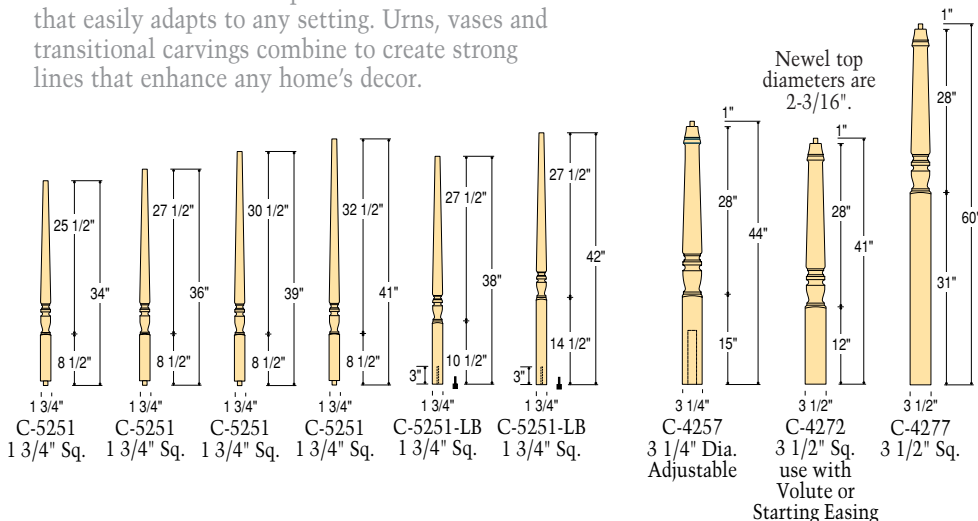

Shown: C-6719 Handrail, C-5251 Balusters, C-4257 Starting Newel, C-7730 LH Volute, C-8010 Starting Step.

MARION POST-TO-POST



C-6719 P1
1 3/4" Plow

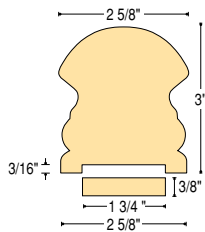

C-6719 P1
with Fillet

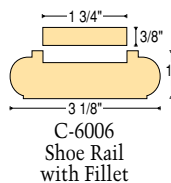

C-6006
Shoe Rail
with Fillet

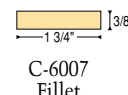

C-6007
Fillet

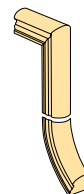

C-7799
2 Riser
No Cap

Newel Top Detail

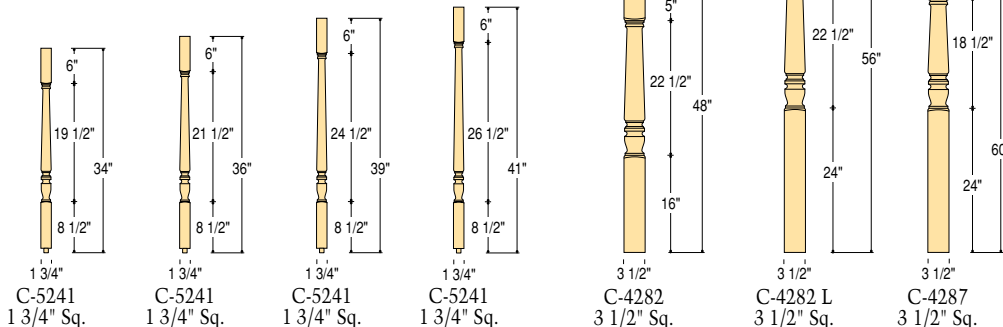
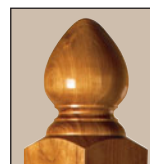

Shown: C-6719 P1 Handrail, C-5241 Balusters, C-4282 Starting Newel.

CHIPPENDALE OVER-THE-POST



C-6719

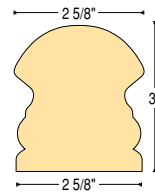

C-6719

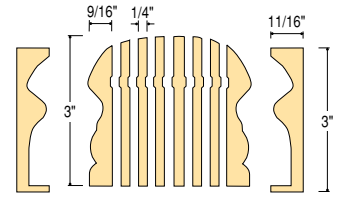

C-6716
Bending Rail with Bending Mould

The Chippendale Collection celebrates the refined style made famous by the master furniture maker, Thomas Chippendale. Balusters and newels feature carefully-crafted flutes and graceful proportions that produce the elegant appeal of this classic design.

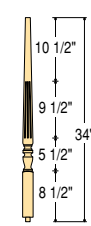

C-5211
1 3/4" Sq. Flute

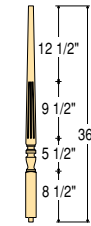

C-5211
1 3/4" Sq. Flute

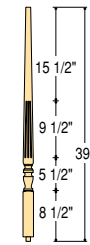

C-5211
1 3/4" Sq. Flute

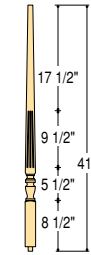

C-5211
1 3/4" Sq. Flute

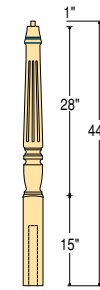

C-4252
3 1/4" Dia. Flute Adjustable

Newel top diameters are 2-3/16".

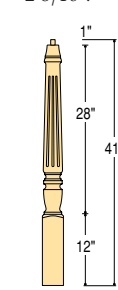

C-4270
3 1/2" Sq. Flute use with Volute or Starting Easing

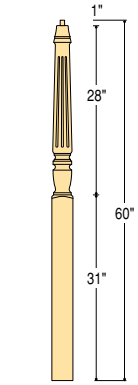

C-4275
3 1/2" Sq. Flute Intermediate or Landing

Shown: C-6719 Handrail, C-5211 Balusters, C-4252 Starting Newel, C-7730 LH Volute, C-7735 RH Volute.

CHIPPENDALE POST-TO-POST



C-6719 P1
1 3/4" Plow

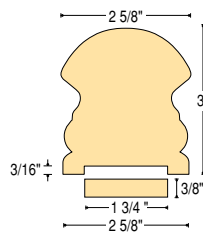

C-6719 P1 with Fillet

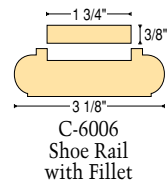

C-6006
Shoe Rail with Fillet

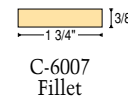

C-6007
Fillet

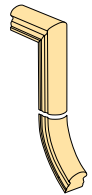

C-7799
2 Riser No Cap

Newel Top Detail

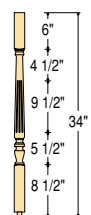
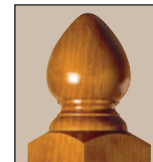

C-5201
1 3/4" Sq. Flute

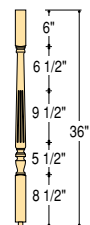

C-5201
1 3/4" Sq. Flute

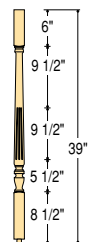

C-5201
1 3/4" Sq. Flute

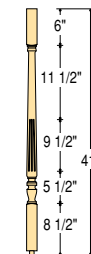

C-5201
1 3/4" Sq. Flute

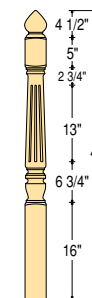

C-4280
3 1/2" Sq. Flute

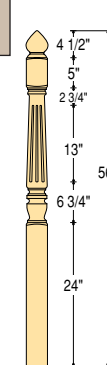

C-4280 L
3 1/2" Sq. Flute

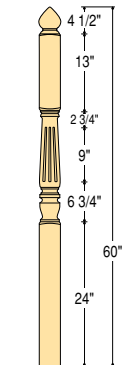

C-4285
3 1/2" Sq. Flute

Shown: C-6719 P1 Handrail, C-5201 Balusters, C-4280 Starting Newel.

ART DECO OVER-THE-POST



C-6810

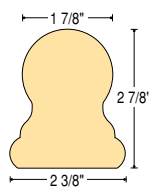

C-6810

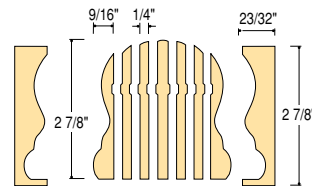

C-6816 Bending Rail with Bending Mould

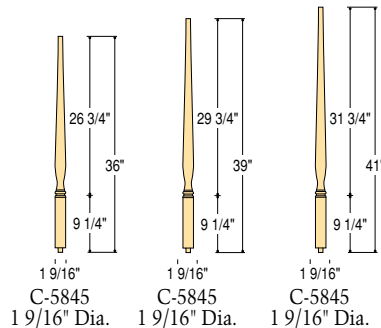

C-5845
1 9/16" Dia.

C-5845
1 9/16" Dia.

C-5845
1 9/16" Dia.

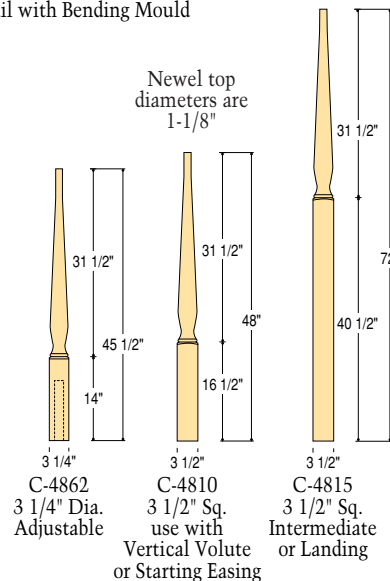

C-4862
3 1/4" Dia.
Adjustable

C-4810
3 1/2" Sq.
use with
Vertical Volute
or Starting Easing

C-4815
3 1/2" Sq.
Intermediate
or Landing

Shown: C-6810 Handrail, C-5845 Balusters, C-4810 Starting Newel, C-7831 Vertical Volute, C-8029 Tread Brackets.

NOTE: Placement of Art Deco Newels will sometimes differ from standard newel locations because of the contemporary styling of the Art Deco fittings.

ART DECO POST-TO-POST



The Art Deco Collection replicates the sense of design that helped transform this fashionable look into an enduring style. Soft curves and elongated tapers unite to emphasize the refreshing proportions that complement so many interior decorating styles.

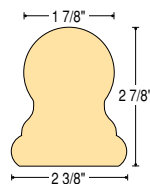

C-6810

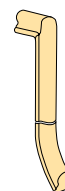

C-7899
2 Riser
No Cap

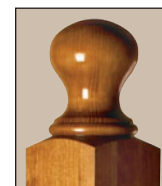

Newel Top Detail

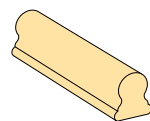

C-6810

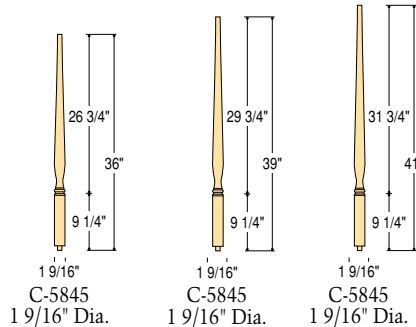

C-5845
1 9/16" Dia.

C-5845
1 9/16" Dia.

C-5845
1 9/16" Dia.

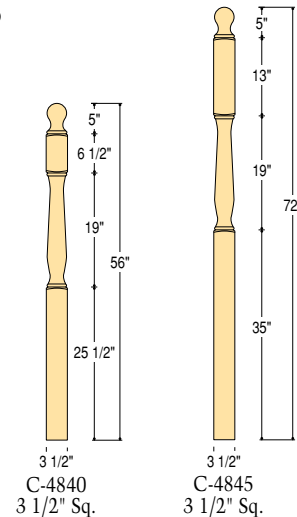

C-4840
3 1/2" Sq.

C-4845
3 1/2" Sq.

Shown: C-6810 Handrail, C-5845 Balusters, C-4840 Starting Newel, C-8029 Tread Brackets.

RICHMOND OVER-THE-POST



The Richmond Collection handrail features a deeply carved profile that transitions gracefully into a richly proportioned peak. Combined with bold turnings, this Collection creates a look that is pleasing to the eye.

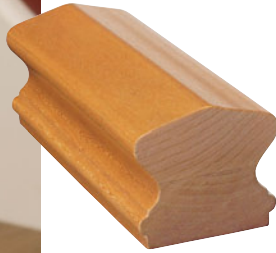

C-6410

Enlarged For Detail
All Long Block (LB)
balusters designed
and shipped with
removable pin.

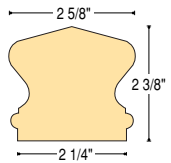
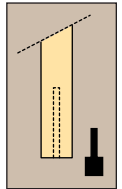

C-6410

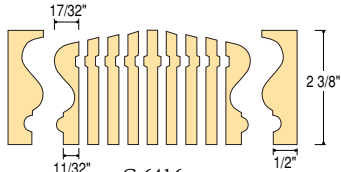

C-6416
Bending Rail with Bending Mould

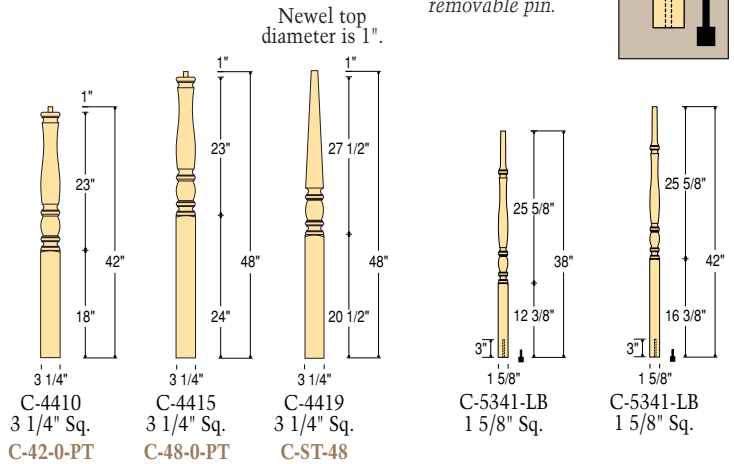

RICHMOND POST-TO-POST



C-6410 P1
1 3/4" Plow

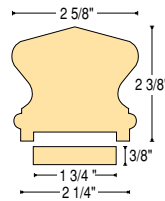

C-6410 P1
with Fillet

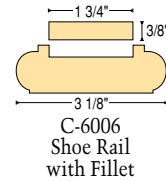

C-6006
Shoe Rail
with Fillet

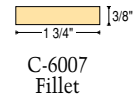

C-6007
Fillet

Shown: C-6410 Handrail, C-4695-F Fluted Box Newel,
C-7499 Gooseneck, C-7412S Up Easing.

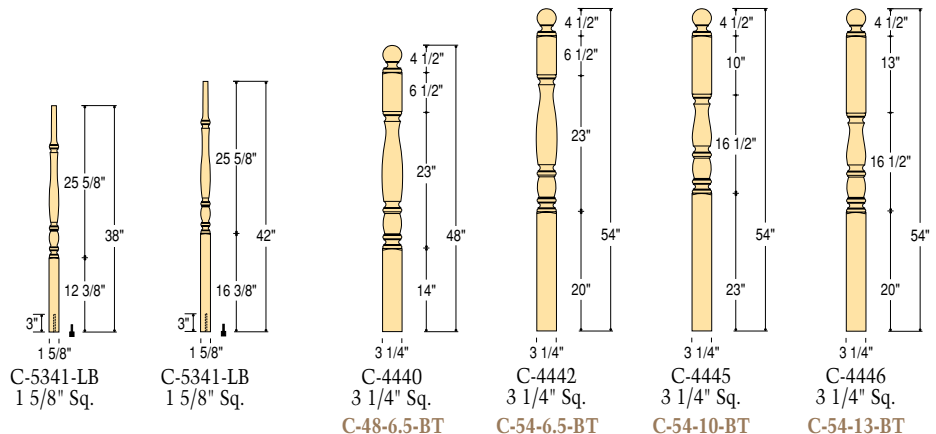

HAMPTON POST-TO-POST



WM Coffman's Hampton Collection offers a combination of pure straight lines, detailed carvings and bold proportions.



C-6005 P1
1 3/4" Plow

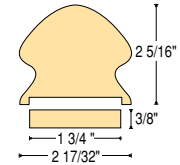

C-6005 P1
1 3/4" Plow
with Fillet

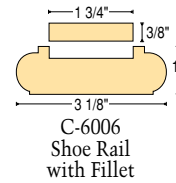

C-6006
Shoe Rail
with Fillet

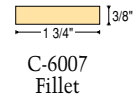

C-6007
Fillet

Shown: C-6005 P1 Handrail, C-6006 Shoe Rail, C-5005 Balusters, C-4004 Starting Newels.

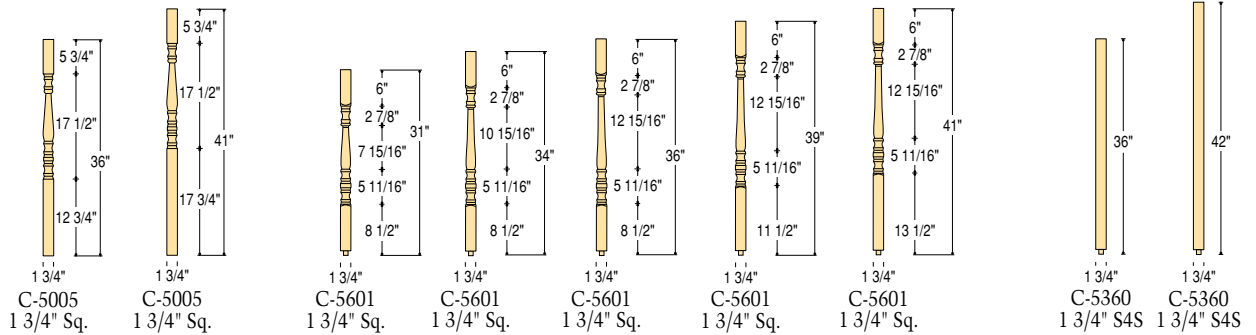

Newel Top Detail

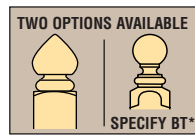

Enlarged For Detail.



Newel Top Detail

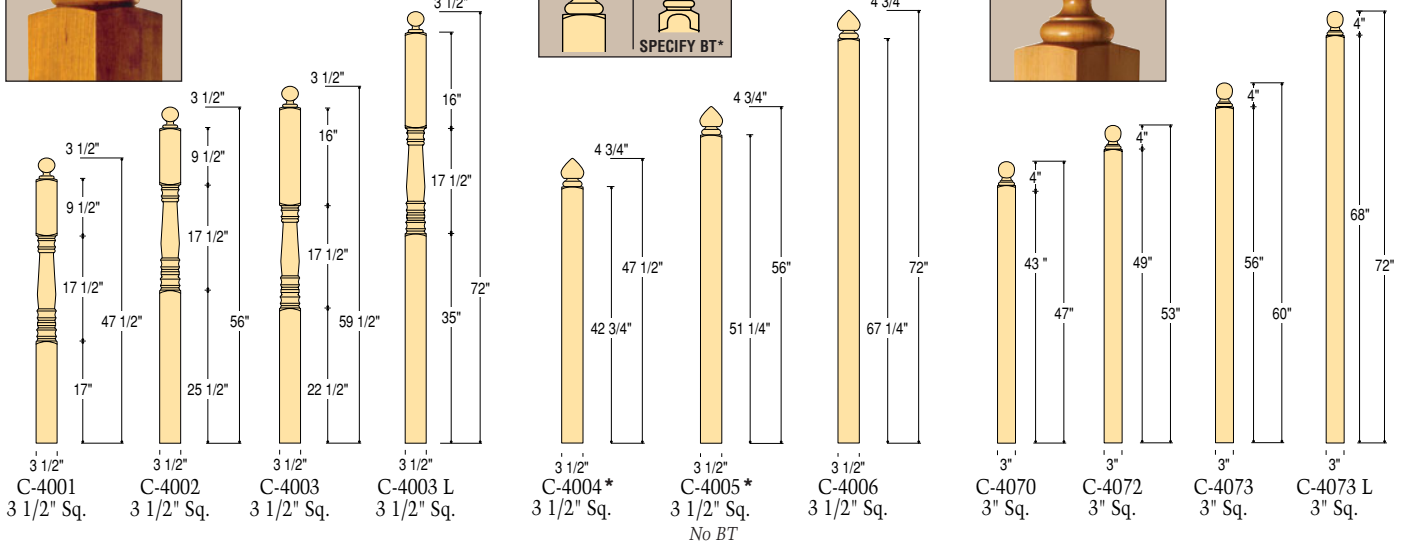



C-6700 P

WM Coffman's Craftsman Collection of newels, balusters and handrails offer the contemporary look of modern components. The straight lines and eased edges will please the eye and the touch.

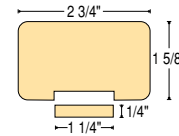

C-6700 P with Fillet

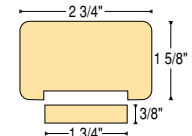

C-6700 P1 with Fillet

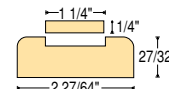

C-6001 Shoe Rail with Fillet

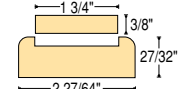

C-6002 Shoe Rail with Fillet

Shown: C-6700 P1 Handrail, C-5360 Balusters, C-4076 Starting Newel.



Top View showing Eased Edge



Shown: C-4074 EE Newel



Shown: C-4076 Newel



C-4074 3" Sq.

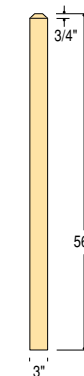

C-4074 EE 3" Sq.

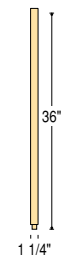

C-5060 1 1/4" S4S

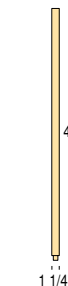

C-5060 1 1/4" S4S



Top View showing Eased Edge.

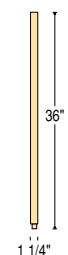

C-5060 EE 1 1/4" Sq.

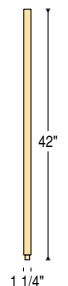

C-5060 EE 1 1/4" Sq.

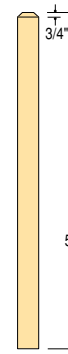

C-4076 3 1/2" Sq.

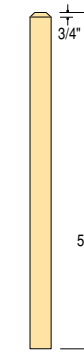

C-4076 EE 3 1/2" Sq.

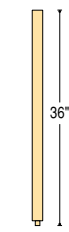

C-5360 1 3/4" S4S

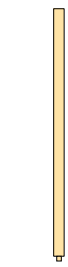

C-5360 1 3/4" S4S

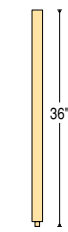

C-5360 EE 1 3/4" Sq.

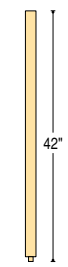

C-5360 EE 1 3/4" Sq.

WALL RAILS

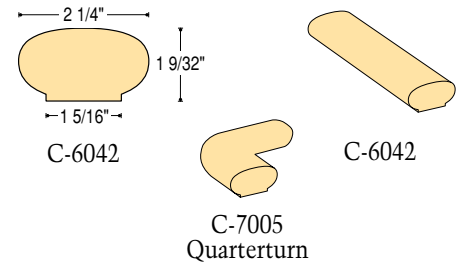
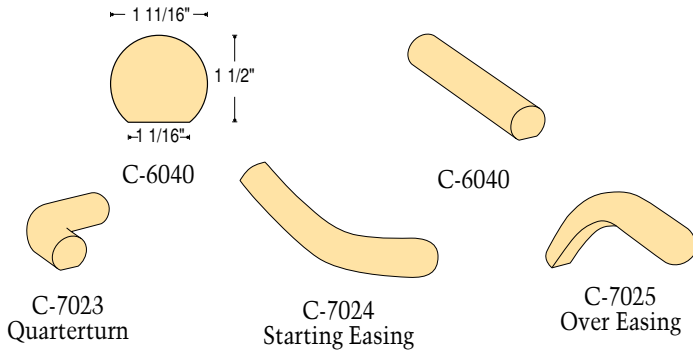

WALL RAIL BRACKETS



C-3631
Standard Wall Rail Bracket
Wall-to-Center - 2-3/4"
Available Finishes
C-3631PB Polished Brass 573002
C-3631BN Brushed Nickel 573039
C-3631CHR Chrome 573020
C-3631FB Flat Black 573022
C-3631SB Satin Black 573023
C-3631ORB Oil Rubbed Bronze 573105



C-3632
Long Arm Standard Wall Rail Bracket
Wall-to-Center - 3-1/2"
Available Finishes
C-3632PB Polished Brass 573038
C-3632BN Brushed Nickel 573138
C-3632ORB Oil Rubbed Bronze 573135



C-3621
Premium Handrail Bracket
Wall-to-Center - 2-3/8"
Available Finishes
C-3621PB Polished Brass 573003
C-3621AB Antique Brass 573009
C-3621BN Brushed Nickel 573007
C-3621CHR Chrome 573006
C-3621BC Brushed Chrome 573010
C-3621B Textured Black 573008
C-3621SB Satin Black 573021
C-3621ORB Oil Rubbed Bronze 573015



C-3622
Premium Handrail Bracket
Wall-to-Center - 3-3/8"
Available Finishes
C-3622PB Polished Brass 573014
C-3622BN Brushed Nickel 573024
C-3622ORB Oil Rubbed Bronze 573025



Use with Iron Collection
C-3611
Iron Handrail Bracket
Wall-to-Center - 3-1/4"
Available Finishes
C-3611BLK Flat Black 573013
C-3611SAT Satin Black 573016
C-3611PC Gray/Black 573012
C-3611ABZ Antique Bronze 573011
C-3611ORB Oil Rubbed Bronze 573019
C-3611ORC Oil Rubbed Copper 573018
C-3611AN Antique Nickel 573017

Rail brackets are shipped with all installation hardware.

ROSETTES

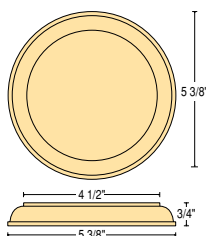

C-7217
Rosette

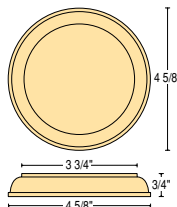

C-7317
Rosette

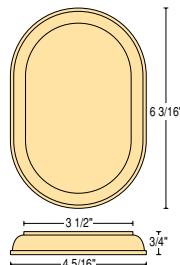

C-7237
Rosette

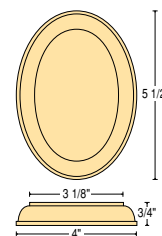

C-7337
Rosette

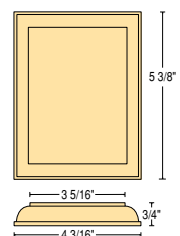

C-7318
Rosette

TRADITIONAL/CLASSIC

STARTING FITTINGS

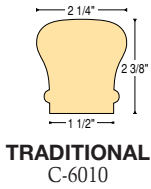

The second digit of the **Fitting** part number identifies the profile and must match the second digit of the **Rail** part number.

Example:

C-70XX Fittings = C-6010 Rail
C-72XX Fittings = C-6210 Rail

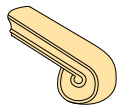
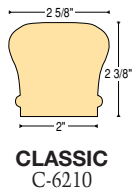

C-7031
Vertical Volute



C-7010
C-7210
Starting Easing
With Cap

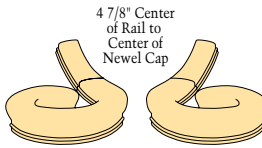

4 7/8" Center of Rail to Center of Newel Cap
C-7030 C-7035
C-7230 C-7235
Left Hand Volute Right Hand Volute

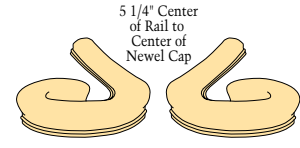

5 1/4" Center of Rail to Center of Newel Cap
C-7033 C-7038
C-7233 C-7238
Left Hand Volute Ascending Right Hand Volute Ascending

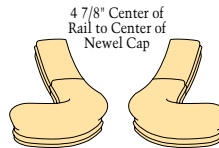

4 7/8" Center of Rail to Center of Newel Cap
C-7040 C-7045
C-7240 C-7245
Left Hand Turnout Right Hand Turnout

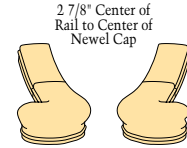

2 7/8" Center of Rail to Center of Newel Cap
C-7041 C-7046
C-7241 C-7246
Left Hand Turnout Right Hand Turnout

TRANSITION FITTINGS



C-7001
Rail Drop

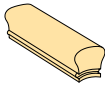

C-7007
C-7207
Coped End



C-7009
C-7209
Returned End



C-7011
C-7211
Level Quarterturn 90°



C-7012S
C-7212S
Up Easing



C-7013
C-7213
Over Easing



7014S
7214S
Up Easing 90°

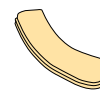

C-7015
C-7215
Starting Easing Returned End



C-7016
C-7216
Over Easing Returned End



C-7018
C-7218
Newel Cap



C-7019
C-7219
Opening Cap



C-7020
C-7220
Tandem Cap



C-7021
C-7221
Quarterturn Cap 90°

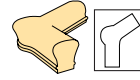

C-7022
C-7222
Level Cap 45°

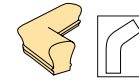

C-7026
C-7226
Level Turn 45°

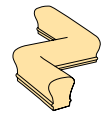

C-7047
C-7247
5° Center to Center Left or Right (LH shown)

GOOSENECK FITTINGS

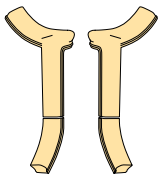

C-7050 C-7055
C-7250 C-7255
Left Hand Right Hand
2 Riser No Cap 90°

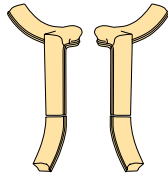

C-7060 C-7065
C-7260 C-7265
Left Hand Right Hand
2 Riser With Cap 90°

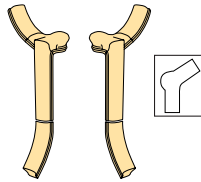

C-7061 C-7066
C-7261 C-7266
Left Hand Right Hand
2 Riser With Cap 45°

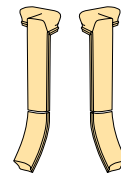

C-7071 C-7076
C-7271 C-7276
Left Hand Right Hand
2 Riser No Cap 90°

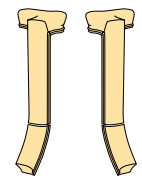

C-7081 C-7086
C-7281 C-7286
Left Hand Right Hand
2 Riser With Cap 90°

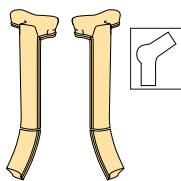

C-7082 C-7087
C-7282 C-7287
Left Hand Right Hand
2 Riser With Cap 45°

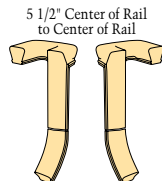

5 1/2" Center of Rail to Center of Rail
C-7091 C-7094
C-7291 C-7294
Left Hand Right Hand
2 Riser Landing Return No Cap 180°

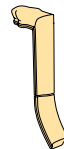

C-7089
C-7289
2 Riser With Tandem Cap

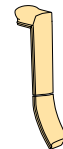

C-7097
C-7297
2 Riser With Cap



C-7098
C-7298
1 Riser No Cap

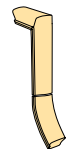

C-7099
C-7299
2 Riser No Cap

BRISTOL/RICHMOND/MARION

STARTING FITTINGS

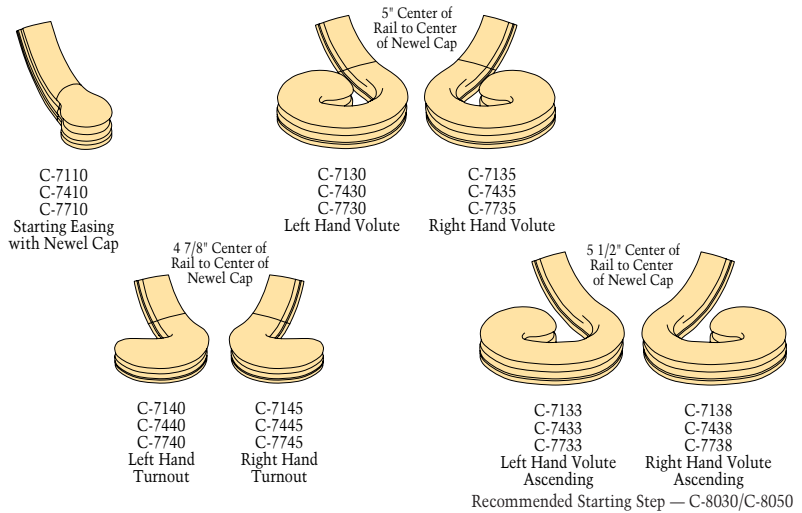
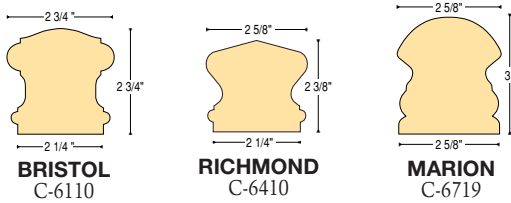

The second digit of the **Fitting** part number identifies the profile and must match the second digit of the **Rail** part number.

Example:

- C-7**1**XX Fittings = C-6**1**10 Rail
- C-7**4**XX Fittings = C-6**4**10 Rail
- C-7**7**XX Fittings = C-6**7**19 Rail

TRANSITION FITTINGS

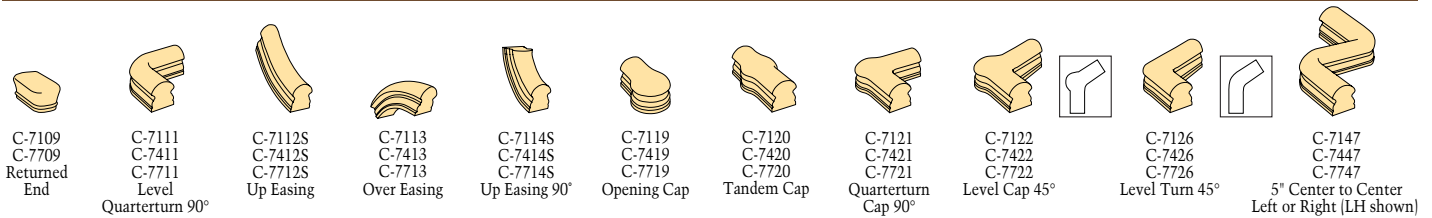

GOOSENECK FITTINGS

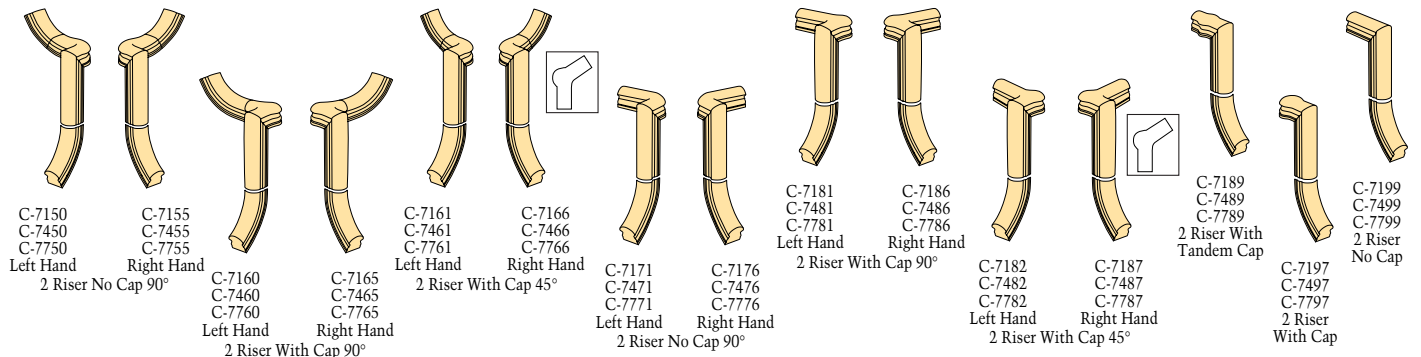

ART DECO

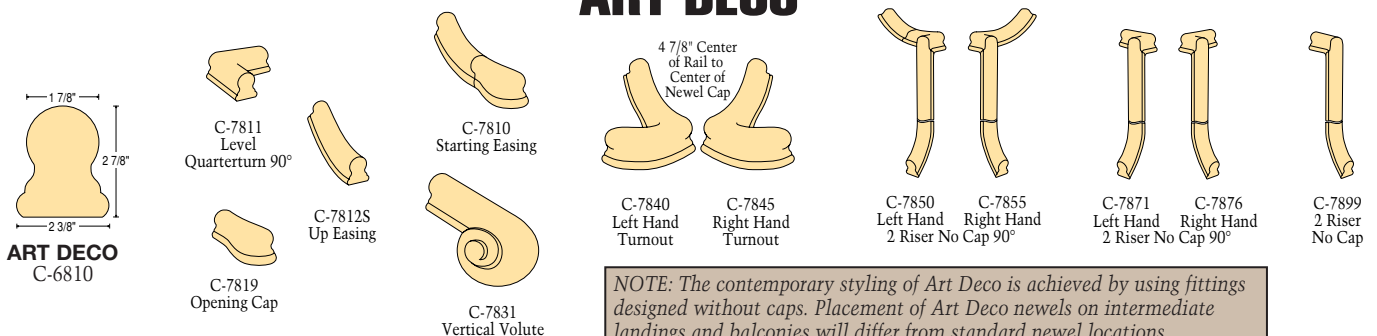

STARTING STEPS

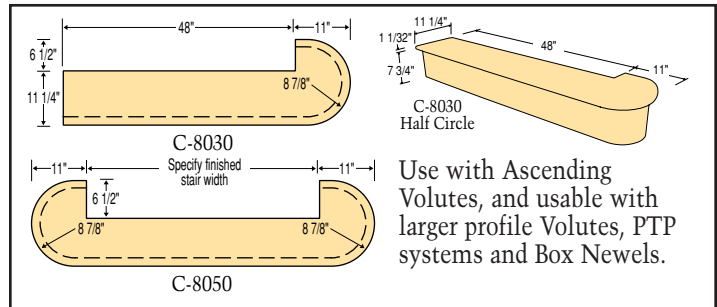
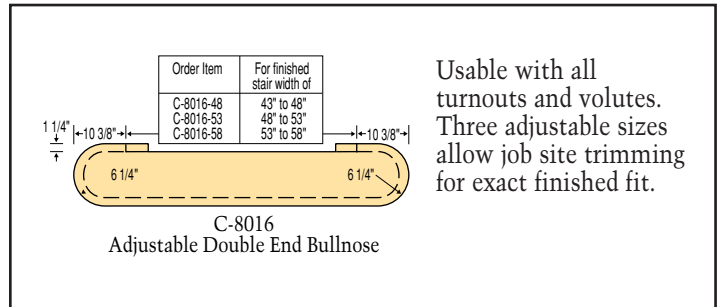
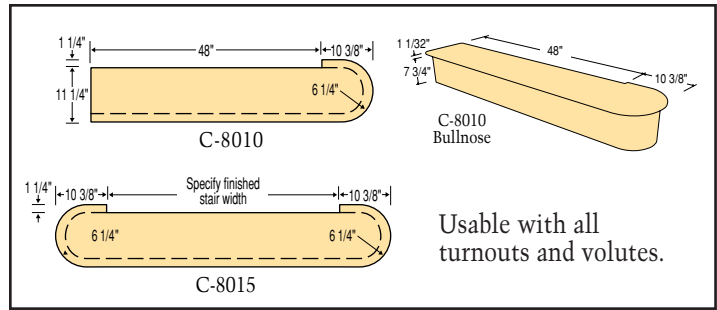

Starting steps are shipped complete with the starting riser, starting tread, and all cove and shoe moulding.

STARTING STEP MOULDING SETS

C-8010COVE
Complete Set C-8010 Cove Moulding (60")
C-8095 Profile

C-8010SHOE
Complete Set C-8010 Shoe Moulding (60")
C-8085 Profile

C-8015COVE
Complete Set C-8015 Cove Moulding (60")
C-8095 Profile

C-8015SHOE
Complete Set C-8015 Shoe Moulding (60")
C-8085 Profile

TREADS AND RISERS

The products in this section are manufactured under highly controlled standards for beauty that will last a lifetime. All are manufactured without the use of finger-joints, excluding landing tread (which may contain a single finger-joint in 14' and 16') and skirtboard.

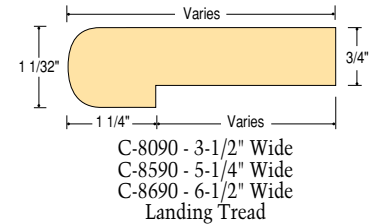
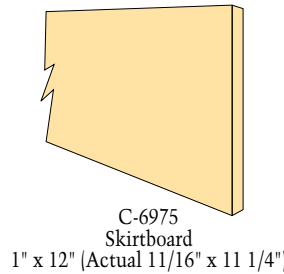
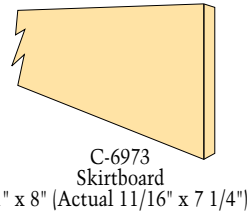
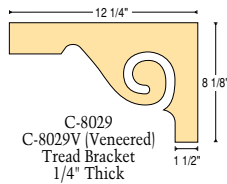
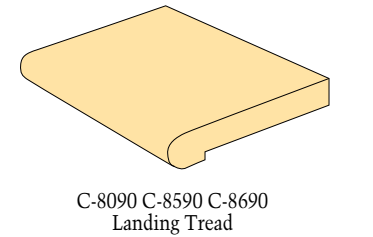
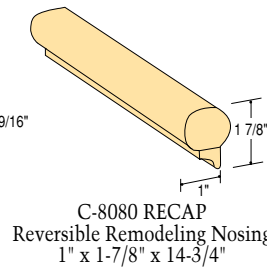
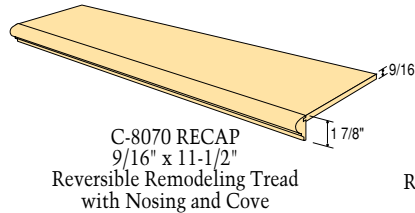
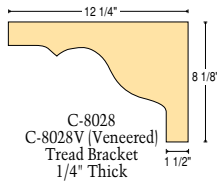
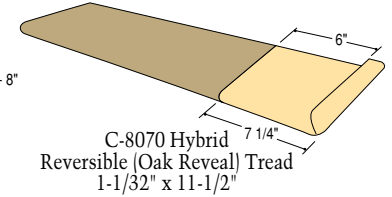
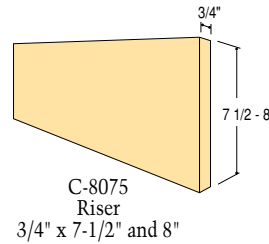
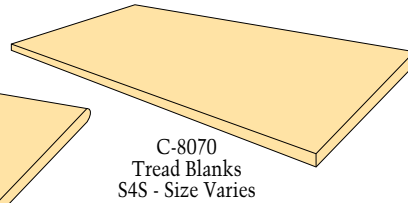
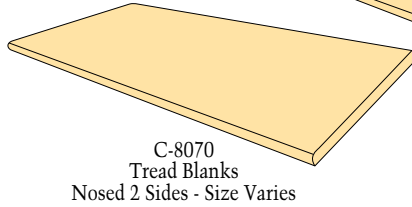
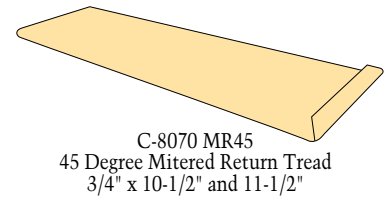
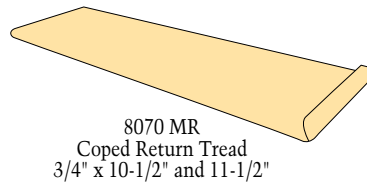
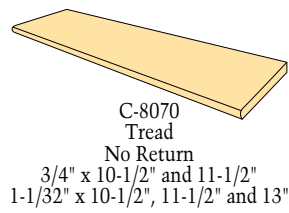

BENDING LANDING TREAD
C-8596 - 5-1/4" 20 PIECE
C-8696 - 6-1/2" 26 PIECE

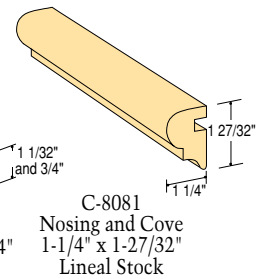
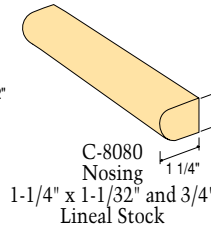
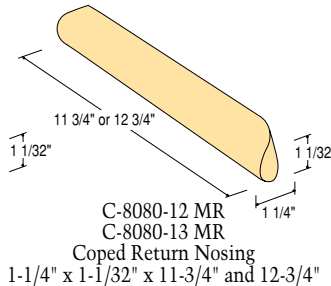
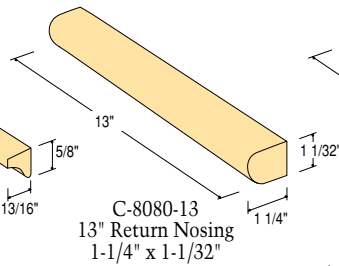
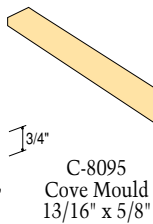
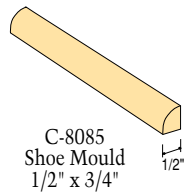

TREAD AND RISER CAPS

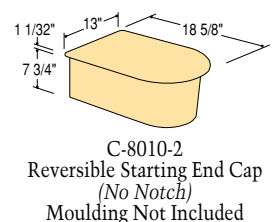
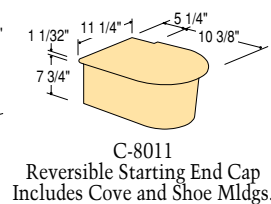
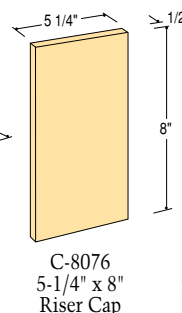
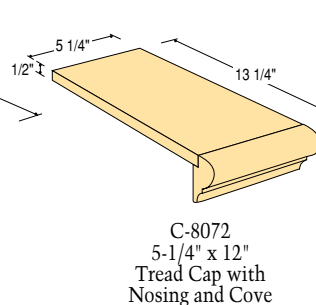
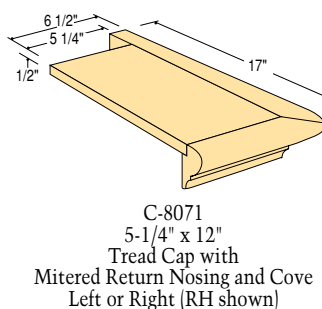

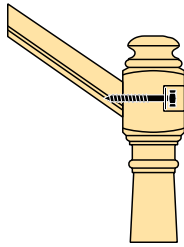

C-3301
Rail & Post Fastener
Includes Fastener, Washer,
Nut and Plugs

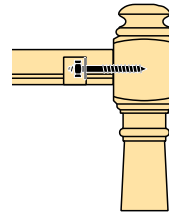

C-3302
Rail Bolt Fastener
Includes Fastener, Washer,
Nut and Plugs

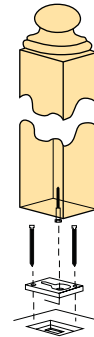

C-3283
Key Lock
2" x 2 5/8" x 3/8"

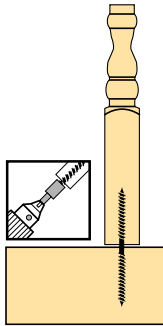

C-3201
Baluster Fastener
Drill Driver Kit
Includes — 4 Baluster Fasteners

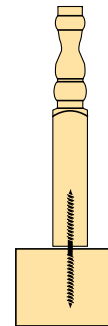

C-3203 — 50 Pack
C-3203-B — 100 Bulk Pack
2-1/2" Baluster Fasteners

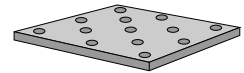

C-3501
Newel Plate Fastener
4-5/8" x 4-5/8"
Includes Plate and
13, 3" Fastening Screws

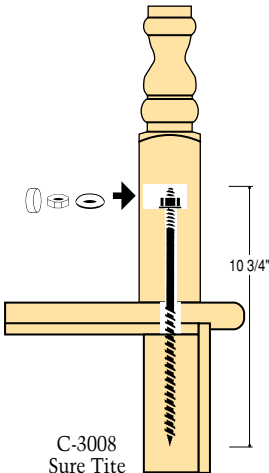

C-3008
Sure Tite
Newel Fastening System
Includes - Lag Bolt, Washer,
Nut and 1-1/2" Plugs

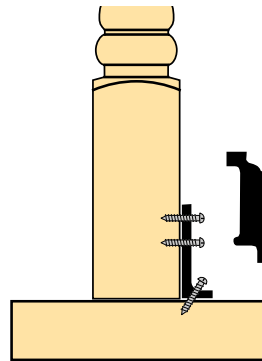

C-3505-30 — 3"
C-3505-35 — 3-1/2"
L-Bracket Post Fastener

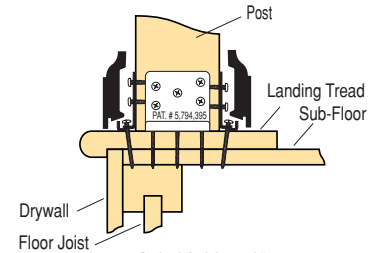

C-3520-30 — 3"
C-3520-325 — 3 1/4"
C-3520-35 — 3 1/2"
4J Post Mounting System
C-3520TRIM
2'-0" Piece Colonial 4J Molding



C-3001
3-1/2" Rail Bolt

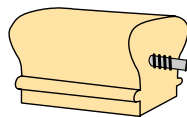

C-3901
Rail Bolt Wrench

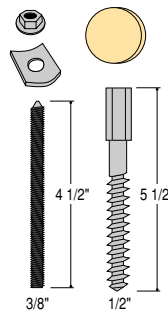
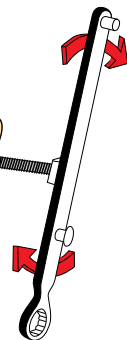

C-3284
Thread Lock

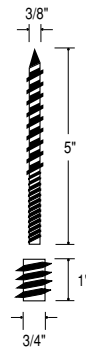

C-3009
Newel Anchoring
Hardware



C-3099
Miter Jig



C-3032
Rail Bolt Driver



C-3010
Flush Rail Plug
1/2" Diameter



C-3015
Button Plug
1/2" Diameter

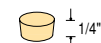

C-3000
Flush Rail Plug
1" Diameter



C-3020
Button Plug
1" Diameter

ITEM	PAGE
IRON COLLECTION	
2XXX	3-10
ACCESSORIES	
23XX	10
29XX	10
3000	30
3001	30
3008	30
3009	30
3010	30
3015	30
3020	30
3032	30
3099	30
3201	30
3203	30
3203B	30
3283	30
3284	30
3301	30
3302	30
3501	30
3505	30
3520	30
3611	25
3621	25
3622	25
3631	25
3632	25
3901	30
7217	25
7237	25
7317	25
7318	25
7337	25
8028	29
8029	21, 29
NEWELS	
2450	9
2452	9
2940	9
2942	9
4001	17, 23
4002	17, 23
4003	17, 23
4003L	17, 23
4004	17, 23
4004BT	17, 23
4005	17, 23
4005BT	17, 23

ITEM	PAGE
4006	17, 23
4007	17
4008	17
4009	17
4010	14
4011	14
4014	14
4015	14
4017	14
4019	14
4030	14
4035	14
4038	14
4039	14
4040	15
4040BT	15
4042	15
4042BT	15
4045	15
4045BT	15
4046	15
4046BT	15
4046SBT	15
4055	15
4055BT	15
4065	14
4070	23
4072	23
4073	23
4073L	23
4074	24
4074EE	24
4075	11
4076	24
4076EE	24
4077	12
4090	12
4091	11
4091-KIT	9
4095	12
4099	13
4111	18
4115	18
4119	18
4162	18
4172	18
4175	18
4176	18
4179	18
4210	16
4215	16
4240	17

ITEM	PAGE
4242	17
4245	17
4252	20
4257	19
4270	20
4272	19
4275	20
4277	19
4280	20
4280L	20
4282	19
4282L	19
4285	20
4287	19
4291-ADJ	11
4410	22
4415	22
4419	22
4440	22
4442	22
4445	22
4446	22
4535	14
4540	15
4542	15
4545	15
4546	15
4547	15
4548	15
4550BT	15
4555BT	15
4556BT	15
4662	16
4690	13
4691	13
4695	12, 22
4810	21
4815	21
4840	21
4845	21
4862	21
4890	13
4891	13
BALUSTERS	
24XX	9
25XX	5, 6, 7
26XX	9
27XX	4, 5
28XX	8
29XX	4, 5, 6, 7, 8

ITEM	PAGE
5005	23
5015	14
5040	14
5060	24
5060EE	24
5067	15
5070	15
5105	15
5141	13, 18
5151	12, 18
5201	20
5211	20
5241	19
5251	19
5341	22
5360	12, 23, 24
5360EE	24
5601	11, 17, 23
5610	14
5611	16
5845	21
RAIL, SHOE and FILLET	
6001	24
6002	24
6005P1	23
6006	17, 18, 19, 20, 22, 23, 25
6007	17, 18, 19, 20, 22, 23, 25
6010	14, 15, 26
6016	14
6040	25
6042	25
6045	15
6050	15
6110	12, 13, 18, 27
6116	18
6210	11, 16, 17, 26
6216	16, 17, 21
6410	22, 27
6416	22
6700	13, 24
6716	19, 20
6719	19, 20, 27
6810	21, 27
6816	21

ITEM	PAGE
FITTINGS	
70XX	25, 26
71XX	27
72XX	26
74XX	27
77XX	27
78XX	27
7005	25
7023	25
7024	25
7025	25
STARTING STEPS	
8010	14, 16, 28
8010-2	29
8011	29
8015	28
8016	28
8030	28
8050	28
TREADS, RISERS, and TREAD ACCESSORIES	
6973	29
6975	29
8070	29
8071	29
8072	29
8075	29
8076	29
8080	29
8080-13	29
8080 MR	29
8081	29
8085	29
8090	29
8095	29
8590	29
8596	29
8690	29

SPECIAL SPECIES

Any Specie* Any Quantity. Any Profile.

Our extensive offering provides the flexibility you will require to create a finely crafted staircase.

Whether you select one of our STANDARD species or a SPECIAL species, your choice will provide a lifetime of warmth, beauty and enjoyment.

(Examples of Special Species shown at right.)

**Any Specie suitable for Stair Part production.
Contact WM Coffman for more information
on individual specie requests.*



Alder



Mahogany



Walnut



Lyptus



White Oak



Hickory



Birch



Ash



Southern Yellow Pine



Brazilian Cherry



Corporate Office • WM Coffman Resources, LLC • 2603 Technology Dr. • Plano, TX 75074

Plano Distribution Center • WM Coffman Resources, LLC • 2603 Technology Dr. • Plano, TX 75074

Marion Distribution Center • WM Coffman Resources, LLC • 1000 Industrial Rd. • Marion, VA 24354

Austell Distribution Center • WM Coffman Resources, LLC • 8080 Troon Circle, Suite 180 • Austell, GA 30168

Phone: 800-810-9204 • Fax: 972-398-9948 • E-mail: sales@wm-coffman.com

www.wm-coffman.com

WMC-183B (05-11) © 2011 WM Coffman LLC

