



CertainTeed
EverNew[®]
Decking & Railing Systems

Welcome to the Decking & Railing Collection.

For more than 100 years, homeowners and building professionals have trusted CertainTeed for the highest quality building products, and continually setting the standards for exciting innovations in style and performance.

Today, that spirit of innovation comes to life in the CertainTeed Decking & Railing Collection with the industry's leading array of colors, styles, and performance. The EverNew product lines offer a combination of superior quality and style that has become the premier choice of homeowners and building professionals.

CertainTeed *Living Spaces*[®]

The comforts of home are no longer defined by four walls. Outside living spaces are “in” as porches, yards and gardens are transformed into beautiful open-air rooms. If you're longing for the joys of fresh air living, CertainTeed can help. Our Living Spaces[®] exterior products suite, including siding, soffit and accessories, porch, decking, railing, fence and roofing products, offers everything you need to create and define your own great outdoors.

CertainTeed's long-standing commitment to innovation, quality and service is firmly rooted in our founding philosophy of “Quality made Certain, Satisfaction Guaranteed.” It's a promise we take as seriously today as we did a century ago.

Get inspiration, see many other great examples of Living Spaces and join in the dialog about improving your outdoor living space by visiting:

 www.facebook.com/certainteedlivingspaces

 www.youtube.com/user/CTLivingSpaces



Polymer Shakes | Vinyl Siding | Soffit

Color shown throughout this brochure is as accurate as printing methods will permit. Please see product samples before making final selection.



Sustainability for a lifetime

CertainTeed respects the environment through the responsible development of sustainable building products and systems. CertainTeed EverNew railing products give building professionals and homeowners confidence that the homes they design, build, maintain, and occupy are made with sustainable materials that enhance every project's performance and beauty.



EverNew Introduction 4

Deck Collection

EverNew® LT 8

EverNew® PT 12

EverNew® Vinyl Decking 16

Decking Accessory

UnderShield® 18

Vinyl Railing Collection

Oxford Routed Railing System 20

Oxford Bracketed Railing System 24

Kingston 28

Vinyl Railing Accessories 30

Composite Railing Collection

Panorama® 34

Porch Posts, Wraps & Columns

Structural Porch Posts 38

Structural Columns 38

Certa-Snap® Wrap 39

Product Matrix 40

On Cover

Deck: EverNew PT in ipe

Railing: Panorama railing with square balusters in white



Create a natural look

Beauty That Lasts

The beauty of EverNew® Decking goes far beyond the surface. That's because EverNew delivers a total package of aesthetic and performance benefits. From its authentic wood look, to its strength and durability, EverNew lives up to its name in every way.

Rich Shades and Textures

EverNew Decking's rich shades and multi-chromatic colors provide the look of natural wood. The natural appearance is enhanced by a woodgrain texture that's deep, beautiful and as close to real as you can get.

Note for optimum decking appearance: When dealing with butt joints or multi-chromatic colors, it is suggested you layout or "rack" 10 or more rows of decking boards across the joists so that you can ensure butt joints are properly staggered and color variations are either randomly dispersed throughout or arranged in the desired pattern. Racking not only allows you to preview how the deck will look installed, but it also provides easy access to decking boards as you work.



Color your world

A Palette of Possibilities

When it comes to designing with color, no one offers more possibilities than CertainTeed. We are the industry leader in vinyl and polymer siding, soffit, trim and accessory color availability. Our broad spectrum of choices ranges from the refreshing pastels of the WaterColors® palette to natural earth tones and deep wood blends.

When you select CertainTeed, you choose design freedom – and the ability to achieve virtually any exterior composition you can imagine.



Perfect together

Coordinated Decking, Railing and Siding

Complete the look with EverNew® Railing. EverNew Railing is offered in a variety of rich colors that are beautiful and durable. Available in vinyl and composites, EverNew has a care-free railing to suit any taste.



Finishing Touches

Details finish the look. EverNew railing comes with decorative options to create just the right style.

Please see product samples before making final selection.

Our commitment to safety

CertainTeed products meet stringent requirements for quality and performance. Safe, secure and durable, our railing and deck systems are engineered to provide years of worry-free enjoyment.

Performance that lasts

EverNew railing products are designed to maintain their integrity over time. Products made of wood may meet code when they're brand new, but can weaken over time — especially after prolonged exposure to the elements. This is an important concern if you're installing railing as a safety barrier on balconies and stairs.

EverNew ensures long-lasting performance by building security into every railing system. Our railing features heavy-duty construction for enduring strength. When it comes to rail-to-post connections, simply using plastic brackets isn't enough. EverNew offers concealed corrosion-resistant stainless steel brackets on our composite railing, and aluminum brackets concealed with molded vinyl covers on our vinyl railing, for critical protection from the elements.

Details make the difference

EverNew railing offers everything you need to install with confidence:

- ◆ Heavy-duty rails offer exceptional durability
- ◆ Secure rail-to-post connections
- ◆ Stainless-steel and aluminum rail mount brackets provide added strength
- ◆ Railing heights approved for deck, balcony, porch and stair applications
- ◆ Concealed hardware won't rust or corrode
- ◆ Splinter-free surfaces
- ◆ Class A flame spread rating for a safer outdoor environment
- ◆ Outstanding warranty coverage with exclusive SureStart™ parts and labor protection



Kingston Vinyl Railing, White with Square Balusters

Meeting the standards of the ICC

The ICC (International Code Council) is an independent, nonprofit organization responsible for the development of national model construction codes. The ICC Evaluation Service, Inc. (ICC-ES) is the leading source of technical information on building codes, products and technology in the United States. ICC-ES conducts technical evaluations of building products, components, methods and materials. Building industry professionals look to ICC-ES evaluation reports for evidence that products and systems meet code requirements.

EverNew railing systems comply with the standards established by the ICC. The Kingston vinyl railing system is officially listed with the ICC-ES as designated in report number ESR-1555. The Oxford railing system has undergone third party testing as designated in report number CCRR-0187. The Panorama composite railing system has undergone third party testing as designated in the report CCRR-0115.

CERTAINTEED EVERNEW®: YOUR ONE-STOP SOURCE FOR QUALITY PRODUCTS

EverNew railing is designed to keep its good looks for years to come, without a lot of maintenance. It won't warp, rot, split or corrode, and it never needs staining or painting.

Easy-living benefits

- ◆ Consistent quality and appearance
- ◆ Easy to install and clean
- ◆ Concealed fasteners
- ◆ Virtually maintenance-free; no painting or staining
- ◆ Class A fire rating
- ◆ Safe and secure
- ◆ Outstanding warranty coverage
- ◆ SureStart™ protection

Rest-assured features

pressure-treated wood	VS.	EverNew® railing and deck systems
Short lifespan		Exceptional durability
Inconsistent quality		Consistent quality
Very high maintenance		Low maintenance
Prone to rot and decay		No rot or decay
Splinters, cracks, knots		No splinters, cracks or knots
Toxic chemical preservatives		No toxic chemical preservatives
Class C fire rating		Class A rating flame spread



Pressure-treated wood

EverNew vinyl

Choose the EverNew system that's right for you

vinyl:

- ◆ Durable construction – weatherable vinyl exterior with aluminum reinforced rails offers low maintenance
- ◆ Precision-fit components provide a snug, secure fit with fast and easy installation
- ◆ Safe and sound metal-to-wood and metal-to-metal rail-to-post connections
- ◆ Convenient packaging in complete section boxed kits
- ◆ Wide variety of accessories, including posts, caps, and post trims that coordinate with all railing systems

capped composite:

- ◆ Solid construction – a blend of PVC and recycled maple wood flour with high-quality PVC capstock for low maintenance
- ◆ Precision-drilled components provide fast and easy installation
- ◆ Secure metal-to-wood rail-to-post connection
- ◆ Convenient packaging in complete section boxed kits or packs for easy color mixing and matching
- ◆ Designed to work with a variety of vinyl accessories, including posts and handrail

With EverNew, you can rest assured that years from now our products will perform as beautifully and securely as the day they were installed. CertainTeed stands behind the EverNew decking and railing products with exceptional warranty protection, for your added assurance of quality and safety.

EverNew® LT



CertainTeed partners with Fiberon, an established leader in new technology and design innovation for the composite decking segment.

EverNew LT in cedar

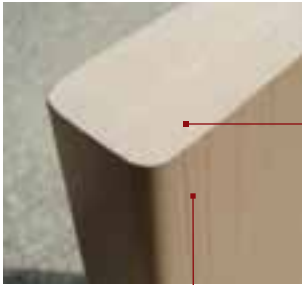

EverNew® LT Decking with Lumenite™ Technology

EverNew® LT Decking's solid-core, PVC can take whatever your life dishes out. This new breed of building material stands up to kids, families, pets, blazing sun, harsh weather – and the spills, thrills, wear and tear that come with them.

Lumenite is a patent-pending innovation from Fiberon that gives EverNew LT Decking unsurpassed performance capabilities. An engineered, fusion-bonded surface technology, Lumenite provides the ultimate in stain, fade and mold resistance.



Stain and Fade Warranty

EverNew LT Decking is not affected by wine, tea, coffee, catsup, barbecue sauces, mustard and the many other drips and spills of outdoor dining. And, extensive testing proves that EverNew LT colors will stay true even after twenty-five years of exposure to the sun and elements.





Jatoba

Spanish Cedar

EverNew LT deck boards and fascia

	Actual Width	Actual Thickness	Available Lengths
5/4x6 Deck boards	5-1/2"	1"	12', 16', 20'
Fascia	11-3/4"	1/2"	12'

Easy, Accurate Installation

EverNew LT installs without pre-drilling and won't mushroom like wood. It can be fastened to a pressure-treated wood substructure and is lighter in weight than other composite decking materials so it's more installer-friendly.



Independent tested as designated in report CCRR-0152.

Optional Hidden Fastener System

For the ultimate in a smooth, clean appearance, EverNew® LT Decking can be installed using a system that "hides" the fasteners. The key to this system is the Deck Pilot®.



CELLULAR PVC
DECKING
WITH LUMENITE™



EverNew® LT Decking is a new breed of cellular PVC decking material. It delivers ultra-low maintenance performance superior to any PVC decking available today. The unique Lumenite™ surface provides unequaled stain, fade and chalk resistance and stands up to whatever life dishes out. Choose from a beautiful array of solid and multi-chromatic colors.

- ◆ Available in: 12', 16' and 20' lengths
- ◆ Ultra-low-maintenance performance superior to any PVC decking in the marketplace
- ◆ Unique, patent-pending Lumenite™ surface provides unequaled stain, fade and chalk resistance
- ◆ Non-organic surfaces are highly mold resistant
- ◆ Infrared heat-reflective surface is cooler underfoot
- ◆ Easy to clean
- ◆ Lightweight for easier handling and installation
- ◆ Class A fire rated for flame spread
- ◆ Optional patent-pending Deck Pilot® tool available for installing hidden fastener system
- ◆ Lifetime Limited Performance Warranty including 25-year Stain and Fade Warranty

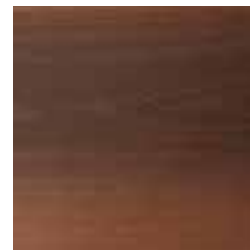

Jatoba



Spanish Cedar

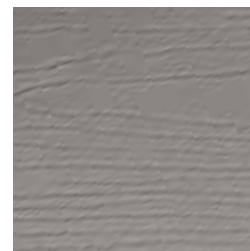

Driftwood



Cedar

EverNew® PT



CertainTeed partners with Fiberon, an established leader in new technology and design innovation for the composite decking segment.

Revolutionary, stunning,
lasting satisfaction



Castle Gray



EverNew® PT Decking with PermaTech™ Innovation

EverNew® PT Decking's solid-core, wood plastic composite is designed for strength, durability, and rigidity. The inorganic, patent-pending PermaTech™ technology by Fiberon provides a resistant surface material and superior stain, fade and mold resistance. Tested to withstand the unexpected, nothing defies the elements quite like EverNew PT Decking with PermaTech innovation.



Tudor

Stain and Fade Warranty

EverNew PT Decking is not affected by wine, tea, coffee, catsup, barbecue sauces, mustard and the many other drips and spills of outdoor dining. And the industry-leading color retention is unmatched by any other product.





Brown



EverNew PT deck boards and fascia

	Actual Width	Actual Thickness	Available Lengths
5/4x6 Deck boards (grooved)	5.4"	.95"	12', 16', 20'
5/4x6 Deck boards (square edge)	5.4"	.95"	20'
Riser Board/Fascia	7-1/4"	3/4"	12'
Fascia	11-1/4"	3/4"	12'

Reversible Boards

Since EverNew PT decking is grained on both sides, two usable faces are available. This reversible board option may reduce waste by 15%.



Optional Hidden Fastener System

The use of the Fiberon approved Hidden Fastener System is highly recommended with EverNew PT grooved decking to create a smooth, unblemished decking surface.

Gunnable Fastener

Install the Fiberon approved Hidden Fasteners 50% faster with the Ballistic Nailscrew Driver, attachment and Ballistic Nailscrews. The Driver Attachment is for use with only the Ballistic Nailscrew Driver and the approved Hidden Fastener used on the grooved boards.

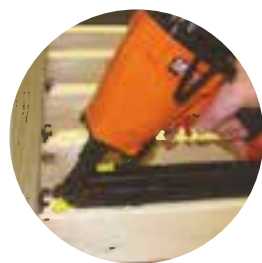

COMPOSITE DECKING WITH PERMATECH™



Get the best of both worlds with EverNew® PT composite decking. EverNew PT features a durable composite core surrounded by an innovative, inorganic protective surface for exceptional stain, fade and scratch resistance. The color offering includes rich, tropical tones with exotic hardwood grains that provide the natural look of wood.

- ◆ Available in: 5/4 x 6" boards in 12' 16' and 20' lengths
- ◆ Innovative inorganic PermaTech™ surface encapsulates the wood plastic composite core – providing stain, fade, and scratch resistance
- ◆ Ultra-low maintenance – easy to clean
- ◆ Reversible boards with four distinct, complementary grain patterns
- ◆ Rich, deep color palette
- ◆ Resistant to termites, splinters, and decay
- ◆ Recycled content creates sustainability
- ◆ Fiberon approved Hidden Fastener system also available
- ◆ 25-year performance warranty including 25-year stain and fade warranty



Castle Gray



Tudor Brown



Rosewood



Ipe



EverNew Vinyl in gray

Oxford with square balusters in white

VINYL DECKING

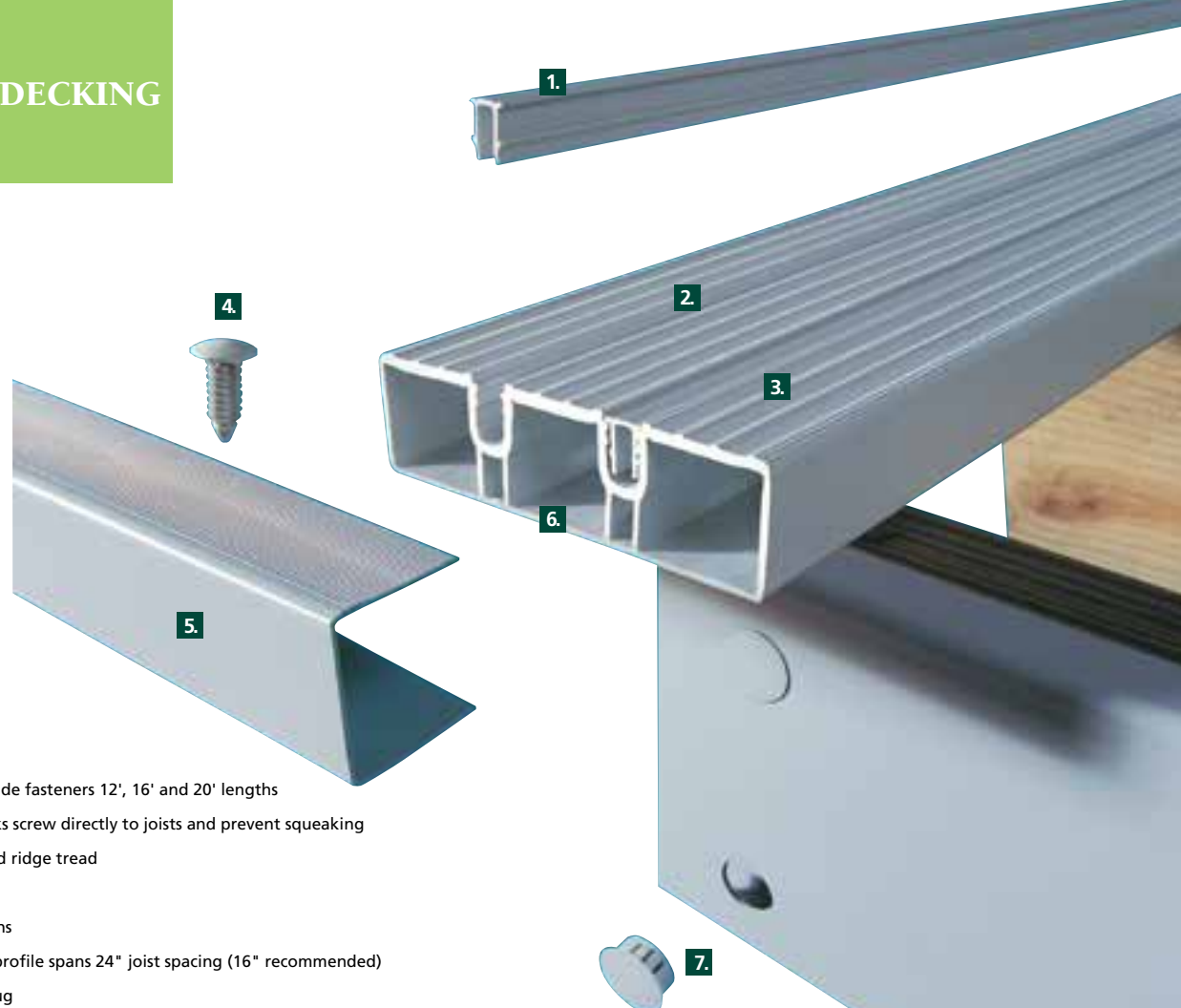

1. Snap-in fill pieces hide fasteners 12', 16' and 20' lengths
2. Easy-to-install planks screw directly to joists and prevent squeaking
3. Safe, non-slip, raised ridge tread
4. End cover fastener
5. End cover 12' lengths
6. Rigid multi-ribbed profile spans 24" joist spacing (16" recommended)
7. 3/4" fascia cover plug

Easy to install, easy to maintain... EverNew's easy to clean deck surface is perfect for busy, no-maintenance lifestyles.

- ◆ Available in 12', 16' and 20' lengths
- ◆ Easy to clean, non-porous vinyl surface
- ◆ Cool to the touch – barefoot friendly™
- ◆ Excellent color retention
- ◆ No visible screws or exposed hardware
- ◆ Lifetime limited transferable warranty with 5-year SureStart™ protection
- ◆ Will not stain from spills

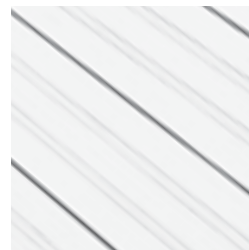

White

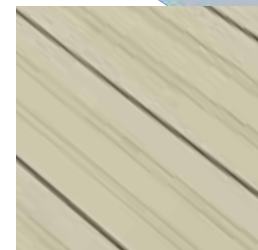

Almond

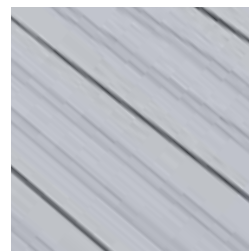

Gray

EverNew® Vinyl deck boards and fascia

	Actual Width	Actual Thickness	Available Lengths
2x6 Deck boards	5-1/2"	1-1/2"	12', 16', 20'
Fascia	1-1/2", 3", 6"	7/8"	8'

Please see product samples before making final selection.



UnderShield® creates new possibilities for your home.

A beautiful deck is easy to love, from the top. Now, you can love your deck from underneath as well, with the beautiful possibilities of UnderShield®. A unique, vinyl shield and ceiling system, UnderShield turns an unsightly deck underside into a dry, beautiful ceiling, creating limitless options for new exterior living spaces.



Create dry patio space under the deck and extend usable living space with a patio, screened porch or hot-tub retreat around the home.



Custom Restoration Millwork® columns and brackets, combined with the UnderShield Water Diversion System, creates a formal yet inviting area.



Under the deck is a perfect area for storage of frequently used outdoor toys, lawn and garden equipment and more.



Beaded in colonial white.

DECKING ACCESSORY

Designed to respond to the needs of building professionals and homeowners, UnderShield is easy to install to new or existing decks, and will maintain unobstructed air flow when properly installed. Panels can run parallel or perpendicular to the home, and an easy-to-use clip creates the desired pitch.

- ◆ Low maintenance water diversion system
- ◆ Easy to install adjustable grid system
- ◆ Concealed clip system
- ◆ Stainless steel hardware provides security and lasting performance
- ◆ High quality vinyl panels
- ◆ Available in 6" x 16' panels
- ◆ Choice of 2 panel styles and 3 colors
- ◆ Suitable for 1 and 2-story residential applications
- ◆ Lifetime limited warranty
- ◆ Installs under the deck joist - no need to worry if the framing is 12" or 16" on center
- ◆ Helps maintain the required ventilation under the deck for most composite deck boards
- ◆ Since it installs under the framing, there is no need to worry about any bracing that may have been installed between joists

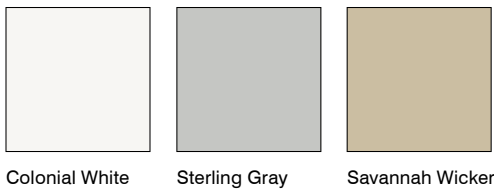
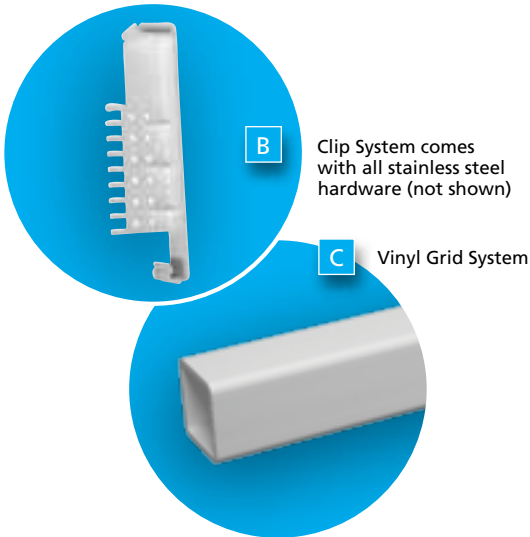

UnderShield is available in beaded or chamfer panels (A). System also includes clips (B), grid system (C), fascia panels and stainless steel hardware (not shown).

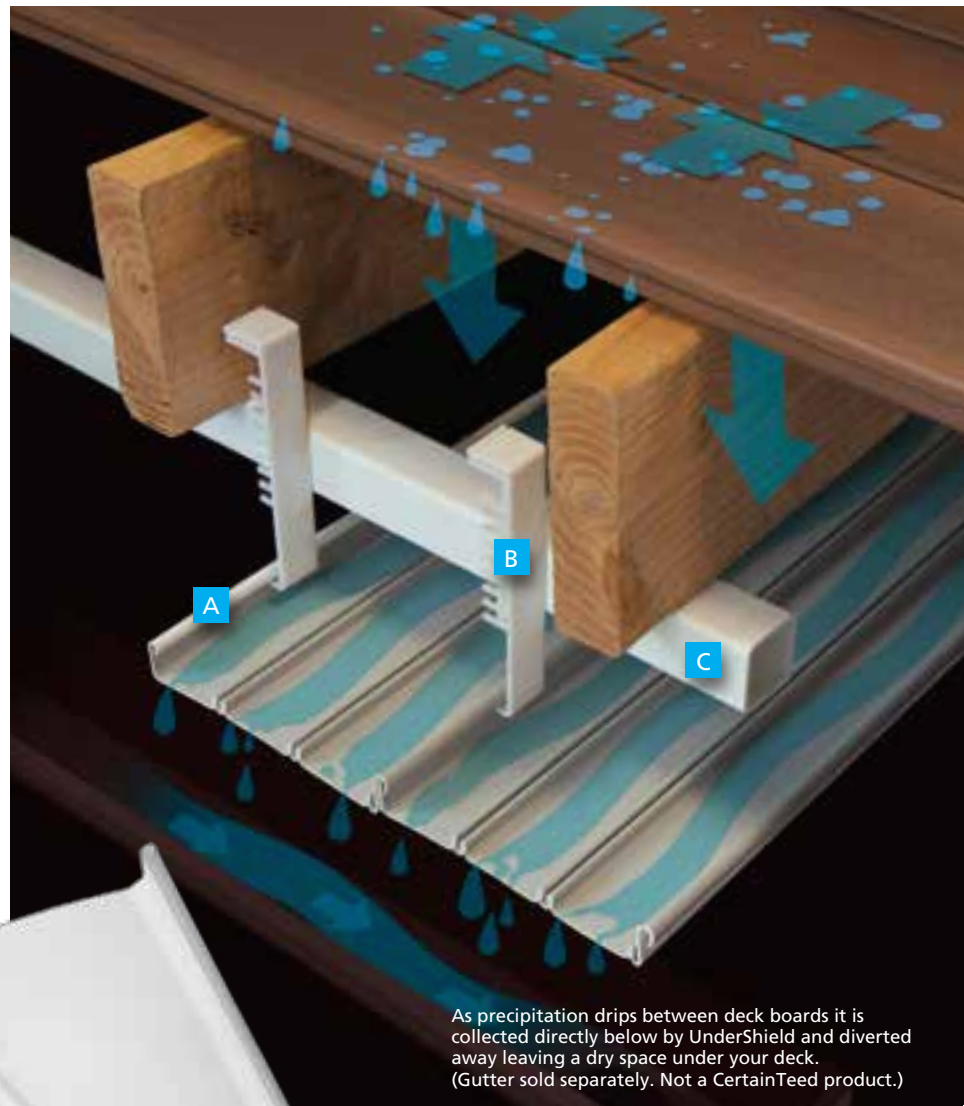

As precipitation drips between deck boards it is collected directly below by UnderShield and diverted away leaving a dry space under your deck. (Gutter sold separately. Not a CertainTeed product.)



Oxford with colonial balusters in white

Metal-to-metal system

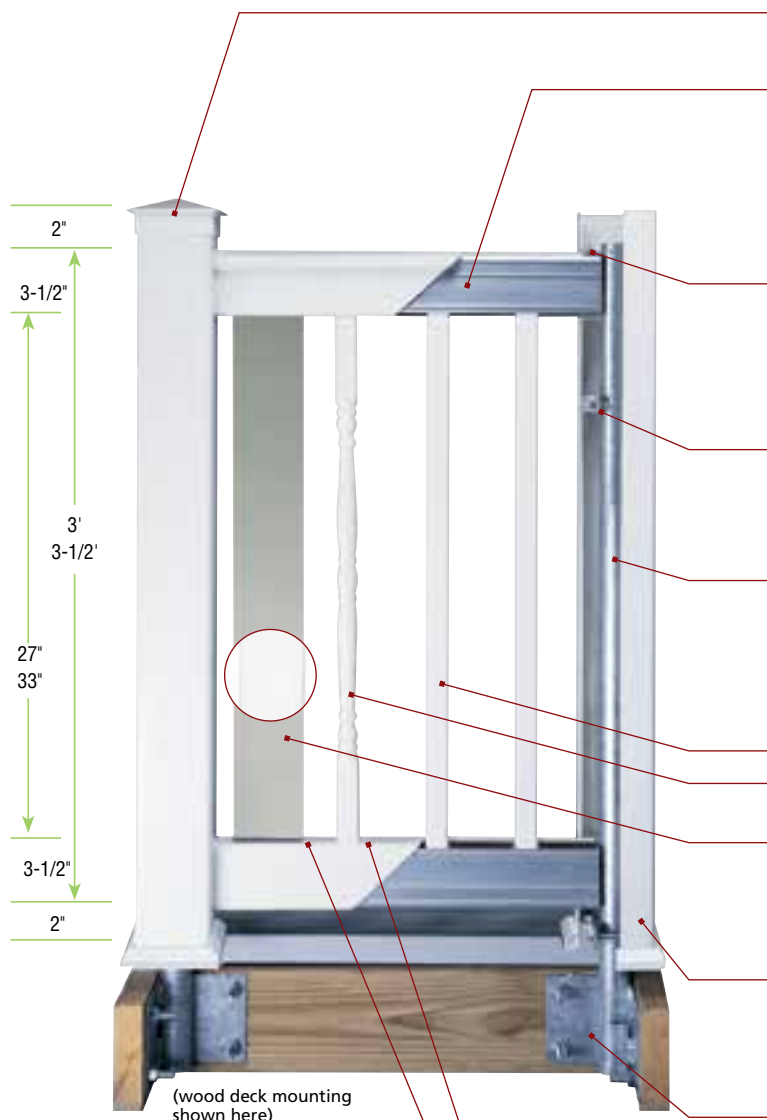

Post caps and trims

Aluminum reinforced top and bottom rail

- 6' standard in flat, stair and steep stair
- 8' standard in flat, stair and steep stair
- 10' standard in flat and stair

Rail plate

- Made of stainless steel
- Screw flange secures top rails inside post
- Oval cut out works for all flat and stair applications



E-Z Set brackets

- Made of aluminum
- Keeps post square and snug



Sturdy post support pipe

- Hot-dipped galvanized steel
- 1-5/8" outside diameter

Baluster styles

- Square
- Colonial (white and almond only)

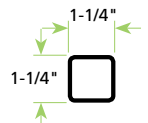

4" tempered glass baluster infill

- Clear available in 3-1/2' only
- Smoked available in 3-1/2' only

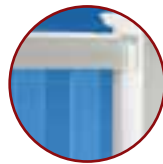

Weather-resistant vinyl post sleeve

- Square available in 3' and 3-1/2' heights

Secure post mounting systems

- Post support kits provided for both wood and concrete applications

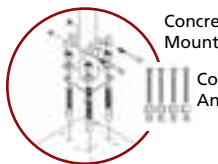

Hardware options for concrete post support kit

- Self leveling kit for concrete post support kits; ideal for ramps
- Stainless steel hardware kit for the concrete post support kit is also available to deliver improved corrosion resistance. Ideal for coastal climates



Attractive precision-fit components

Baluster hole spacing

- Top and bottom rails are routed to accept 1-1/4" x 1-1/4" balusters.
- Stair baluster spacing is wider to account for racking.

Stair/step section

- Post center spacing on diagonal 6' section covers 68" at 32°
- 8' section covers 90" at 32°, 10' section covers 117" at 32°
- 6' section covers 71" at 42°, 8' section covers 96" at 42°

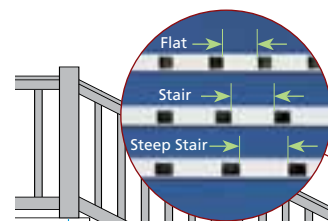

Standard: 25° min–37° max
Steep stair: 37° min–42° max

*Refer to product matrix for actual product specifications.

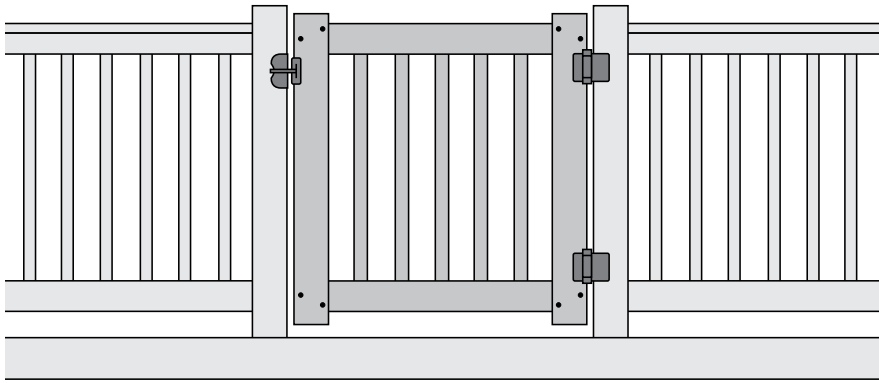

Oxford Gate Kit

Improved design for enhanced performance and easier ordering.

- Heavy duty internal aluminum frame.
- Stainless steel fasteners.
- Features 2x4 rails.
- High quality gate hardware.
- Available in all colors, both heights, and square & colonial balusters
- Easy to assemble

Routed Post Options

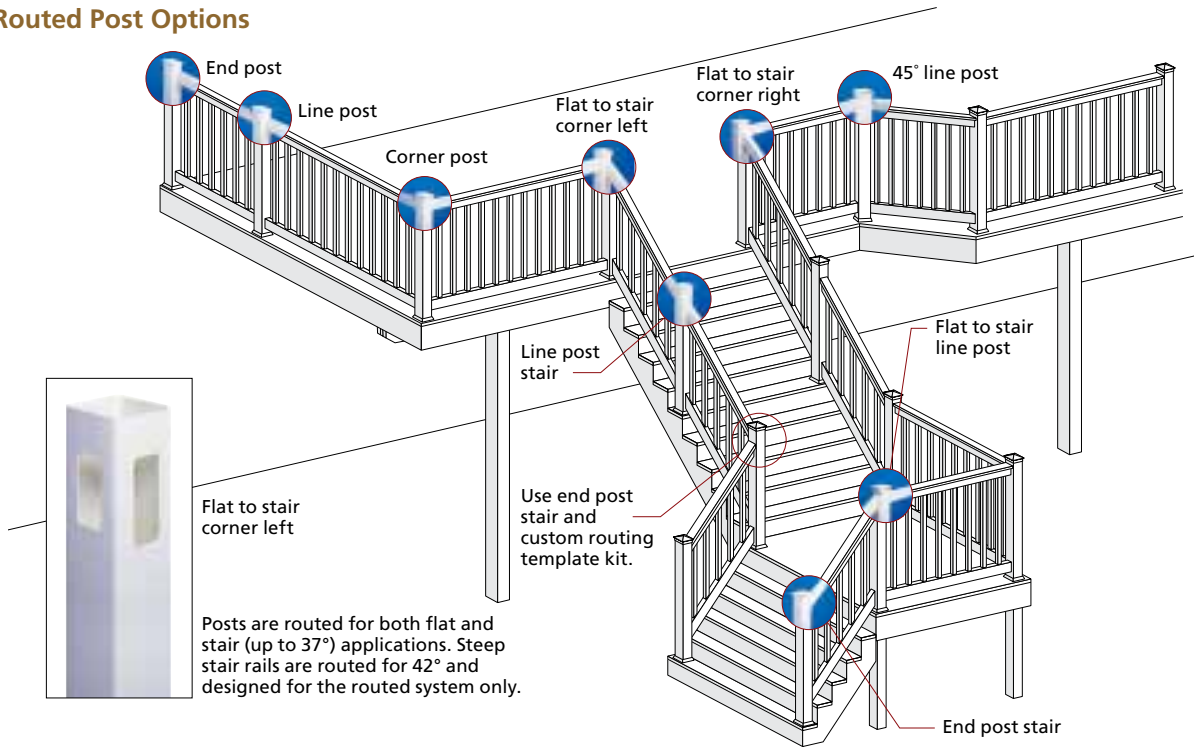

Posts are routed for both flat and stair (up to 37°) applications. Steep stair rails are routed for 42° and designed for the routed system only.

EverNew glass balusters combine high-end style with the quality and performance features that are distinctly CertainTeed. Our glass balusters are designed to work with either the routed or bracketed Oxford railing system.

- ◆ 3-1/2' height offers a clearer view with less obstructions
- ◆ Easy to order — no need for custom sizing
- ◆ Easy to install — routed rails eliminate the need to fasten and screw balusters without extra brackets
- ◆ Beveled baluster works for both flat and stair applications
- ◆ 4" x 3/8" tempered glass
- ◆ Choice of clear or smoked glass
- ◆ Independent tested as designated in report CCRR-0187
- ◆ Suitable for one and two family dwellings and townhomes that are not more than three stories high
- ◆ Lifetime limited transferable warranty with SureStart™ protection
- ◆ Post connections available in bracketed and routed



Clear Balusters



Smoked Balusters

VINYL ROUTED RAILING SYSTEM

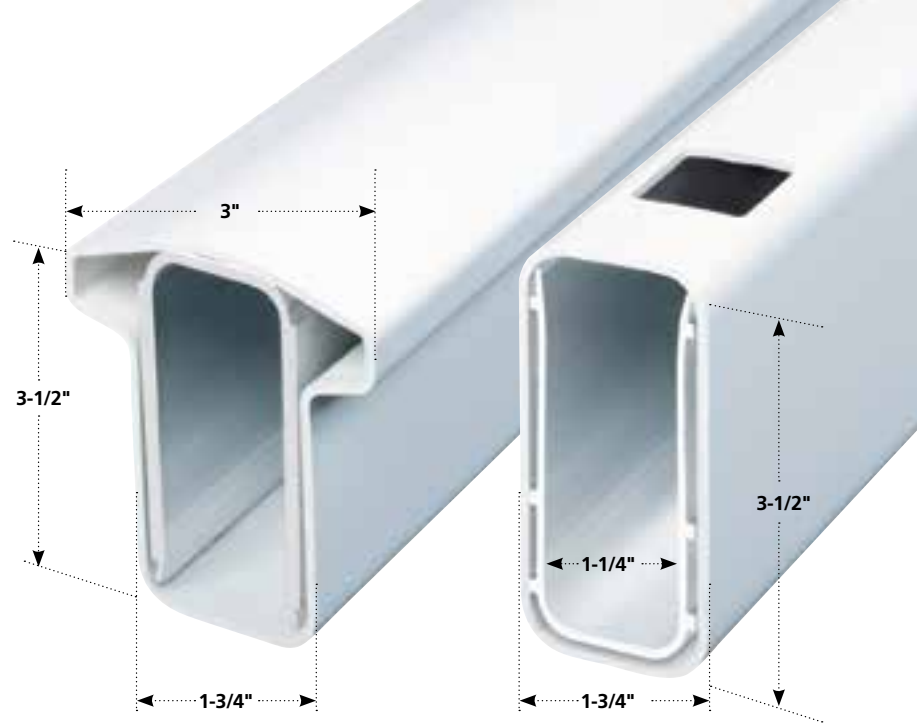

For safe, secure vinyl railing applications, there's no better choice than the Oxford routed system. The routed Oxford system features a unique internal rail-to-post connection and hidden hardware, so there are no unsightly brackets to detract from the look of the railing. The aluminum reinforced rail connects to a sturdy galvanized post support kit inside the routed post, for a completely concealed metal-to-metal connection.

- ◆ Popular T-rail top rail and 2x4 bottom rail system for a completely seamless appearance
- ◆ The ultimate hidden hardware system
- ◆ Internal rail-to-post connection means no unsightly brackets
- ◆ Complete metal-to-metal, the aluminum reinforced rail connects to a sturdy galvanized post support kit inside the routed post
- ◆ Posts routed specifically for all post applications – post support kits mount to wood and concrete installations
- ◆ Choice of three colors and three baluster styles
- ◆ Available in two heights and three lengths
- ◆ Independent tested as designated in report CCRR-0187
- ◆ Suitable for residential and commercial applications – including multifamily and over three story installations
- ◆ Meets IBC standards for building safety
- ◆ Class A rating for flame spread
- ◆ Lifetime limited transferable warranty with 5-year SureStart™ protection



White



Almond



Clay



Oxford with square balusters in white

Oxford



EverNew PT in ipe
Oxford in white with glass balusters in clear

Metal-to-wood system

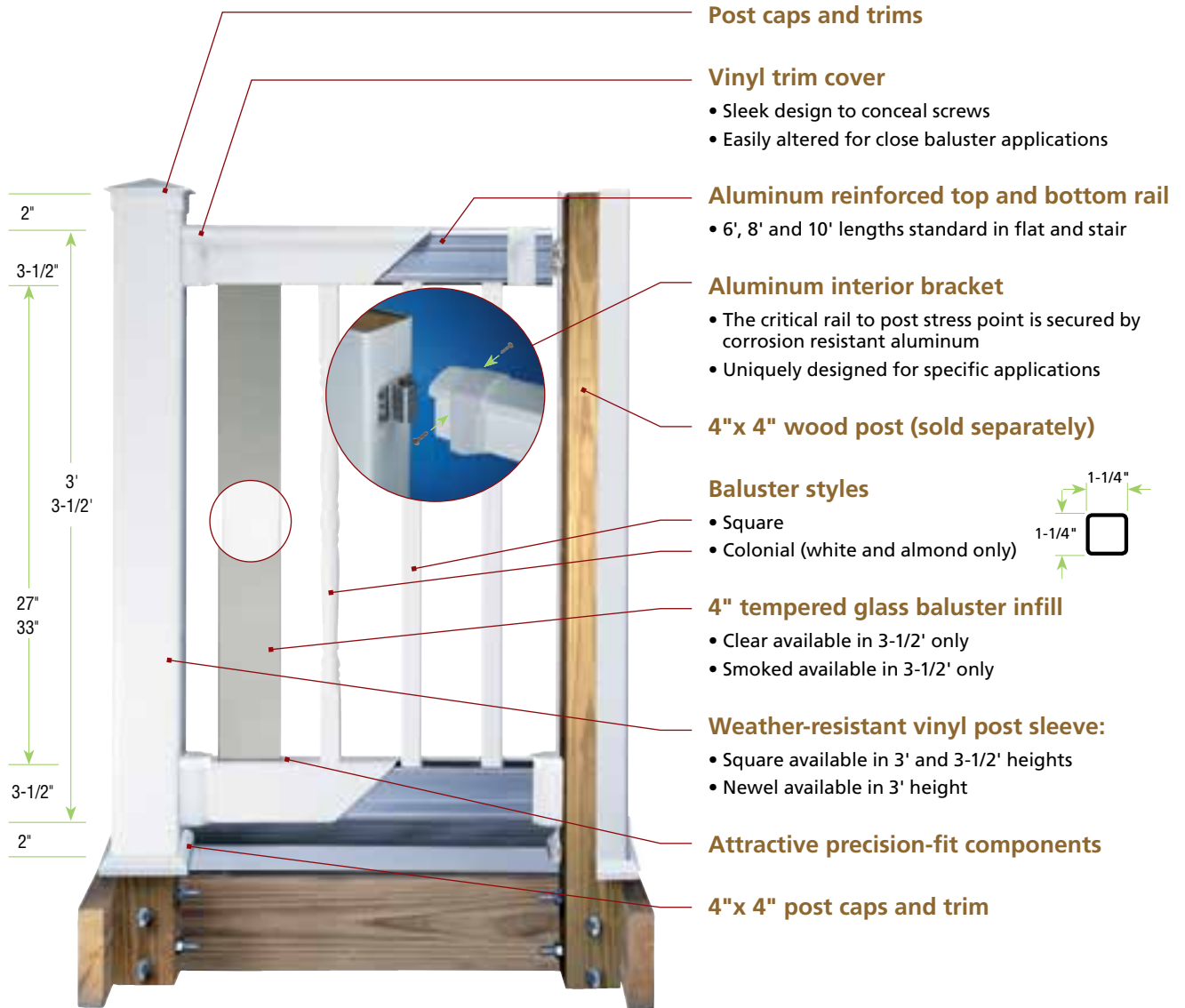

Post caps and trims

Vinyl trim cover

- Sleek design to conceal screws
- Easily altered for close baluster applications

Aluminum reinforced top and bottom rail

- 6', 8' and 10' lengths standard in flat and stair

Aluminum interior bracket

- The critical rail to post stress point is secured by corrosion resistant aluminum
- Uniquely designed for specific applications

4" x 4" wood post (sold separately)

Baluster styles

- Square
- Colonial (white and almond only)

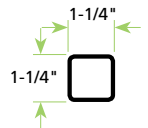

4" tempered glass baluster infill

- Clear available in 3-1/2' only
- Smoked available in 3-1/2' only

Weather-resistant vinyl post sleeve:

- Square available in 3' and 3-1/2' heights
- Newel available in 3' height

Attractive precision-fit components

4" x 4" post caps and trim

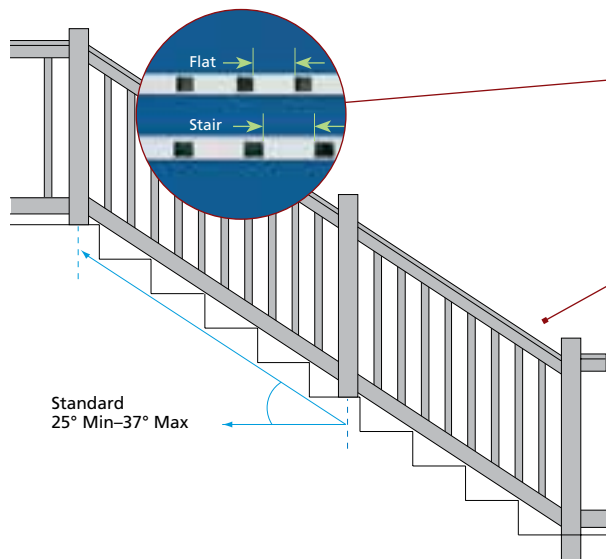

Baluster hole spacing

- Top and bottom rails are routed to accept 1-1/4" x 1-1/4" balusters.
- Stair baluster spacing is wider to account for racking.

Stair/step section

- Post center spacing on diagonal: 6' section covers 68" at 32°
- 8' section covers 90" at 32°, 10' section covers 117" at 32°

*Refer to product matrix for actual product specifications.

Oxford Bracket Options – Uniquely designed for specific applications

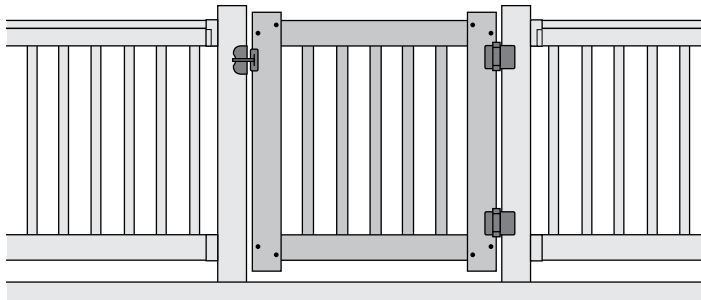

Oxford Gate Kit

Improved design for enhanced performance and easier ordering.

- Heavy duty internal aluminum frame.
- Stainless steel fasteners.
- Features 2x4 rails.
- High quality gate hardware.
- Available in all colors, both heights, and square & colonial balusters
- Easy to assemble



flat



column (minimum 8" round)



stair (field alteration)



45°



Secure Connection

Aluminum brackets and corrosion-resistant stainless steel screws complete the connection between post and rail to provide a strong and reliable system.



Oxford in white with colonial balusters

VINYL BRACKETED RAILING SYSTEM

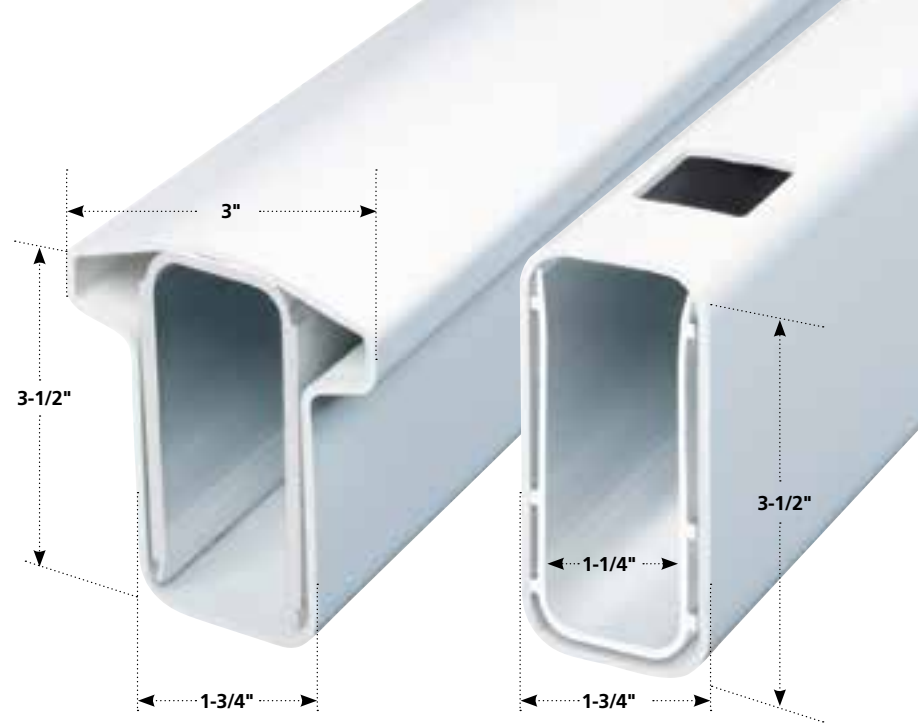

Designed for use with existing wood posts, the Oxford bracketed railing system offers everything you need for a safe and secure railing installation. Oxford goes the extra mile with standard features like concealed aluminum rail mount brackets and stainless steel screws, for long-lasting strength and peace of mind.

- ◆ Popular T-rail top rail and 2x4 bottom rail system for sleeve-over installations
- ◆ Durable, heavy-duty design
- ◆ Aluminum rail mount brackets provide a safe and secure, metal-to-metal rail-to-post connection for greater strength and longevity
- ◆ Unique molded vinyl bracket covers designed for flat, stair, column, and 45° applications
- ◆ Brackets come complete with corrosion-resistant stainless steel screws
- ◆ Choice of three colors and three baluster styles
- ◆ Available in two heights and three lengths
- ◆ Concrete post support kit with bracket reinforcement blocks available (see page 30)
- ◆ Independent tested as designated in report CCRR-0187
- ◆ Suitable for residential and commercial applications – including multifamily and over three story installations
- ◆ Meets IBC standards for building safety
- ◆ Class A rating for flame spread
- ◆ Lifetime limited transferable warranty with 5-year SureStart™ protection



White



Almond

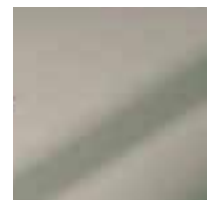

Clay



Oxford with square balusters in white

Kingston

1. Vinyl trim cover
 - Sleek design to conceal screws and streamline appearance
 - Easily altered for close baluster applications
2. Rugged aluminum reinforced top and bottom rail
 - 6', 8' and 10' lengths standard in flat and stair (10' flat only)
3. Aluminum interior bracket
 - The critical rail to post stress point is secured by corrosion resistant aluminum
 - Uniquely designed for specific applications
4. Baluster styles
 - Traditional (3' White and Almond only)
 - Square
5. Attractive precision-fit components
6. Molded crush block
7. 4"x 4" post caps and trims available
8. Weather-resistant vinyl post sleeve in either square or newel available in 3' and 3-1/2' heights (not shown)



Kingston with traditional balusters in white

VINYL RAILING SYSTEM

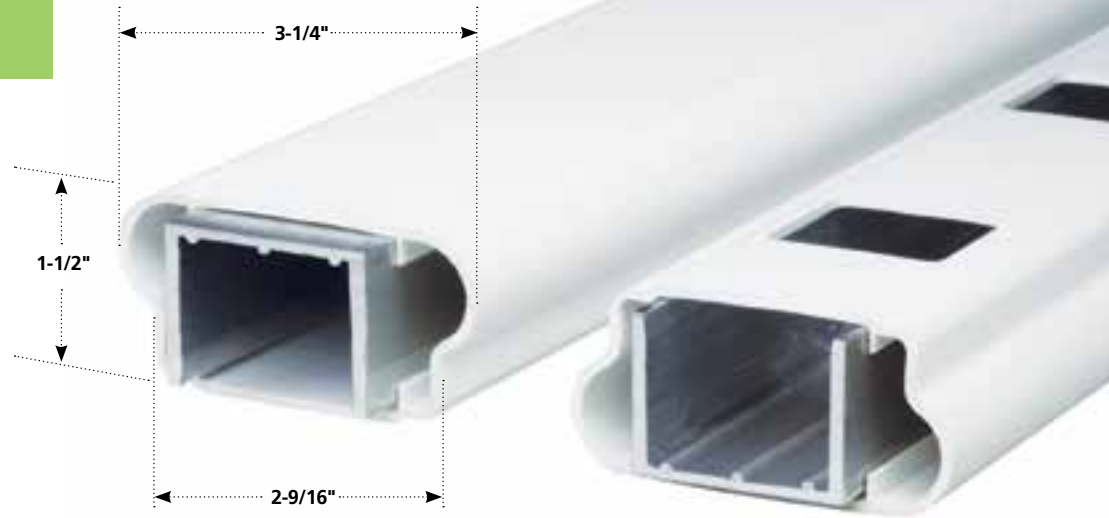

Kingston offers premium features you'd expect to find on higher-end systems, including high-quality aluminum rail mount brackets for superior safety and security. Secured by provided stainless steel fasteners, the aluminum brackets are completely concealed by molded vinyl covers, so you never have to worry about rust or corrosion.

- ◆ Classic bread-loaf rail design (on both top and bottom rails) for sleeve-over installations
- ◆ Premium features at an affordable price
- ◆ Aluminum rail mount brackets provide a safe and secure metal-to-metal, rail-to-post connection for greater strength and longevity
- ◆ Unique molded vinyl bracket covers designed for flat, stair, column, 45° and 22-1/2° applications
- ◆ Concrete post support kit with bracket reinforcement blocks available (see page 30)
- ◆ Choice of three colors and two baluster styles
- ◆ Available in two heights and three lengths
- ◆ Listed with the ICC-ES as designated in report ESR-1555
- ◆ Suitable for one- and two-family dwellings and townhouses not more than three stories in height
- ◆ Class A rating for flame spread
- ◆ Lifetime limited transferable warranty with 5-year SureStart™ protection

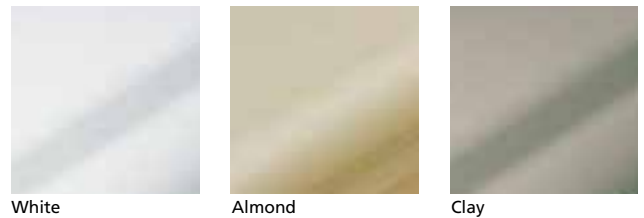

Trim covers

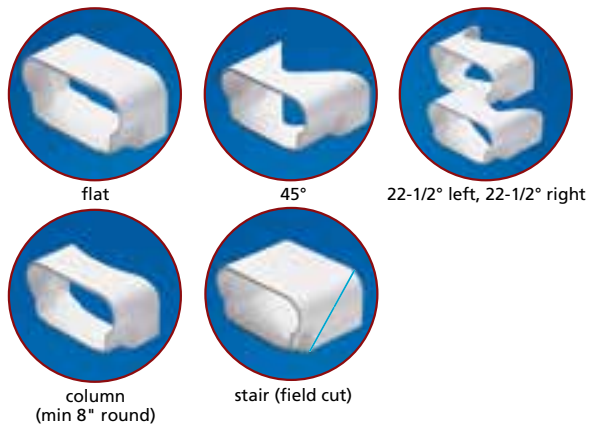

Kingston Gate Kit

Designed for enhanced performance and easy ordering.

- Heavy duty internal aluminum frame.
- Stainless steel fasteners.
- Features 2" x 3-1/2" rails.
- High quality gate hardware.
- Available in all colors, all heights and all balusters
- Easy to assemble

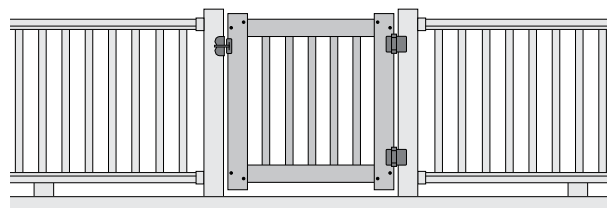

Baluster hole spacing

- Top and bottom rails are routed to accept 1-1/2" x 1-1/2" balusters.
- Stair baluster spacing is wider to account for racking.

Stair/step section

- Post center spacing on diagonal:
6' section covers 70" at 32°;
- 8' section covers 95" at 32°

*Refer to product matrix for actual product specifications.

Square post and caps

Vinyl blank posts available in...

4"x4": 38", 44", 48", 51-1/2", 107"; **5"x5":** 68", 107";

6"x6": 120"



Flat cap internal Flat cap external New England cap Flat Pyramid cap (6"x6" only)



Gothic cap Ball cap New England cap w/ deco finish*

Square post

Newel post and caps

4"x4" newel post and caps create a more traditional look on your EverNew railing. Blank newel posts available in 38" and 44" for white 3' styles only.



Newel post



King cap



Queen cap

Post trim

Post trim can be used for finishing vinyl posts. Available in White, Almond, Clay and Sierra Blend.



4-piece post trims
Available in 4"x4" and 5"x5"
(matches porch post trims)
Also available in 6"x6"
(Adjusts to fit 4" to 6-1/2" posts)



1-piece post trims
Available in 4"x4" and 5"x5"
2-piece post trims
Available in 4"x4" and 5"x5"

Optional post support kit and accessories for bracketed vinyl railing



The Mount Post Support

The Mount provides easy bracketed system installation on most surfaces.

- ◆ Choice of: concrete and wood/composite hardware kits available (sold separately from post support)
- ◆ Leveling plate included
- ◆ Available in 3' and 3-1/2' heights

	Oxford	Kingston
 flat cap internal	✓	✓
 flat cap external	✓	✓
 New England cap	✓	✓
 New England cap with deco finish	✓	✓
 ball cap	✓	✓
 gothic cap	✓	✓
 square post	✓	✓
 king cap	✓	✓
 queen cap	✓	✓
 newel post	✓	✓
 4-piece post trim	✓	✓
 1 and 2 piece post trim	✓	✓

Not all accessories available in all colors and textures. Refer to product catalog for colors and style availability.

*Aluminum cap with your choice of black or antique bronze finish. Available in 4"x4" and 5"x5" sizes

**ADD THE PERFECT
FINISHING TOUCH WITH
DECORATIVE POST CAPS AND TRIM**

Decorative Post Caps and Post Trim for 4" x 4" posts



post cap in patina

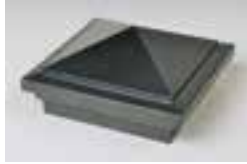

post cap in antique gray



post cap in antique brown



post cap in antique copper



post cap in antique gold



solar post cap in patina



solar post cap in antique gray



solar post cap in antique brown



solar post cap in antique copper



solar post cap in antique gold



post trim in patina

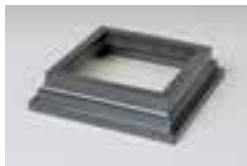

post trim in antique gray



post trim in antique brown



post trim in antique copper



post trim in antique gold

Solar Post Caps for 4" x 4" and 5" x 5" posts



solar post cap in white



solar post cap in black

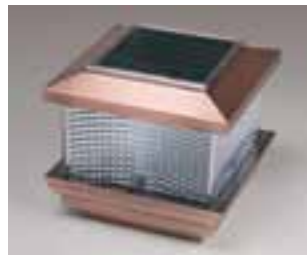

solar post cap in copper



solar post cap in stainless

Solar Wedges



solar wedge in white



solar wedge in black



solar wedge in copper



solar wedge in stainless

Above Decorative post caps, solar caps, and trims fit 4" x 4" posts.
Solar lighting modules — eco-friendly LED lights for the ultimate in solar-powered accent lighting.

Vinyl handrail component system

- ◆ Complies with ADA (Americans with Disabilities Act) requirements for grippable hand rails
- ◆ 1-1/2" diameter gripping area
- ◆ Continuous hand rail runs
- ◆ Safe for stair and ramp applications
- ◆ Aluminum reinforced construction reduces bowing and provides enduring strength
- ◆ Functional finishing touches: post and wall returns, end caps, return loops and a convenient straight joiner
- ◆ Unique adjustable internal joiner accommodates any transition – 0° to 90° bends
- ◆ Installs easily on site with no preformed fittings
- ◆ Ideal for use with EverNew railing systems
- ◆ Virtually maintenance free
- ◆ Class A rating for flame spread
- ◆ Lifetime limited warranty
- ◆ EZ Set bracket kit available for attachment to routed system



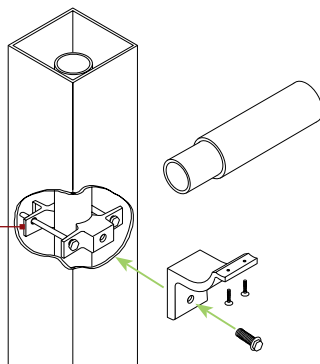

White

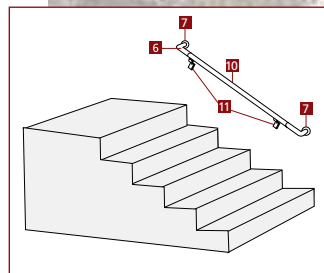
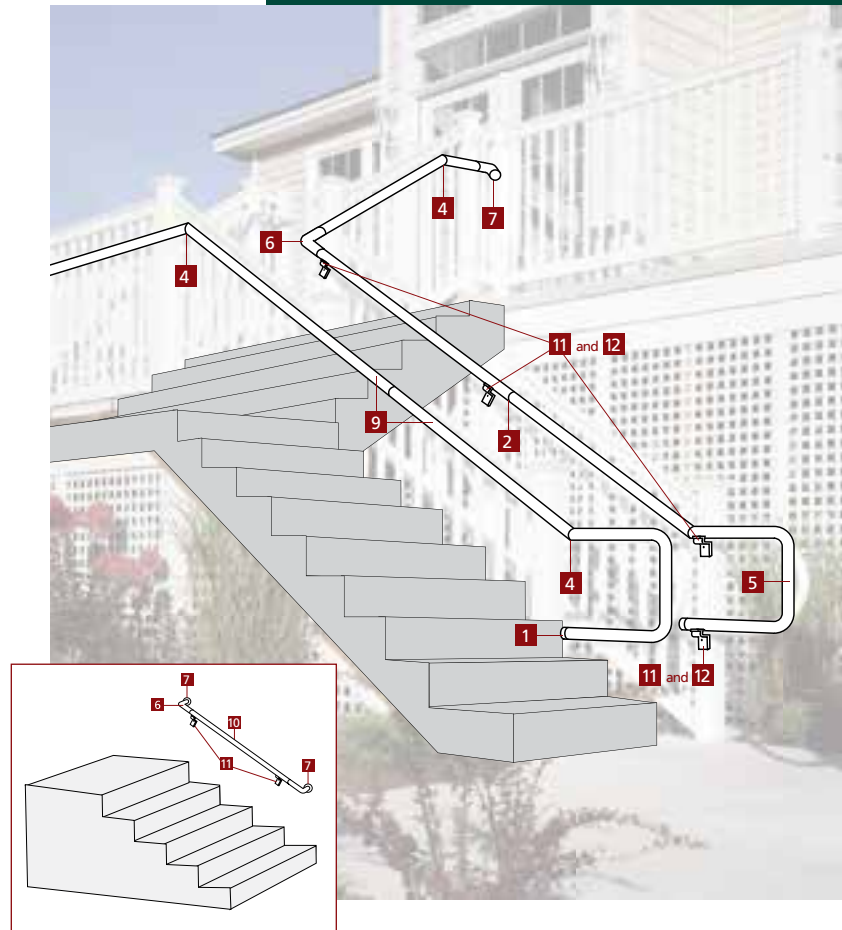

Note: Hand rail depicted is not free standing and must be anchored to walls or guardrail using hand rail bracket assembly (74028/74029). Space a maximum of 6' on center and as close as possible to both sides of any joint. (ADA compliant at 6ft spans)

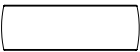

1. 1-1/2" diameter vinyl end cap
2. Straight aluminum joiner 
3. Straight wall return (includes vinyl trim)
4. Adjustable aluminum internal joiner 
5. 1-1/2" OD ADA 180° return loop
6. 1-1/2" OD - 90° corner - includes two 3" aluminum joiners
7. 1-1/2" OD - 90° wall return - includes 3" aluminum joiner
8. 1-1/2" OD x 80" vinyl hand rail with aluminum insert
9. 1-1/2" OD x 104" vinyl hand rail with aluminum insert
10. 1-1/2" OD x 120" vinyl hand rail with aluminum insert
11. Hand rail bracket assembly
12. Hand rail EZ Post attach kit



Kingston Gate

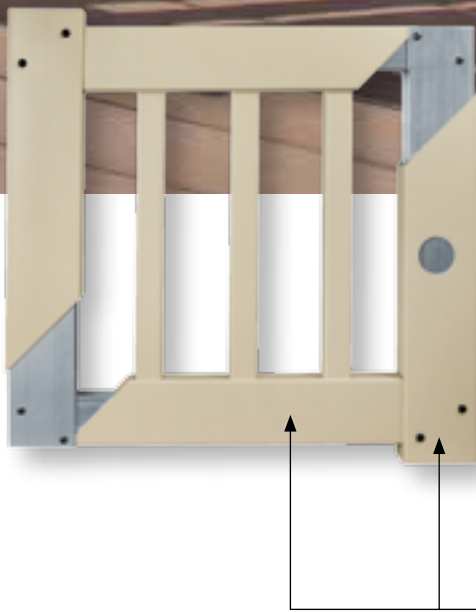

EverNew Gate Kits

EverNew gates feature a heavy-duty internal aluminum frame for sturdy construction that's built to last and stainless steel fasteners to prevent corrosion.

- ◆ Available for Oxford and Kingston railing systems.
- ◆ Kit includes all parts needed to build a railing gate up to 60" wide
- ◆ Aluminum reinforced uprights and rectangular rails
 - Balusters
 - Upright caps
 - Stainless steel screws
 - Black nylon gate hinges
 - Latch



Panorama with square balusters in white

The solid look and feel of wood without the maintenance

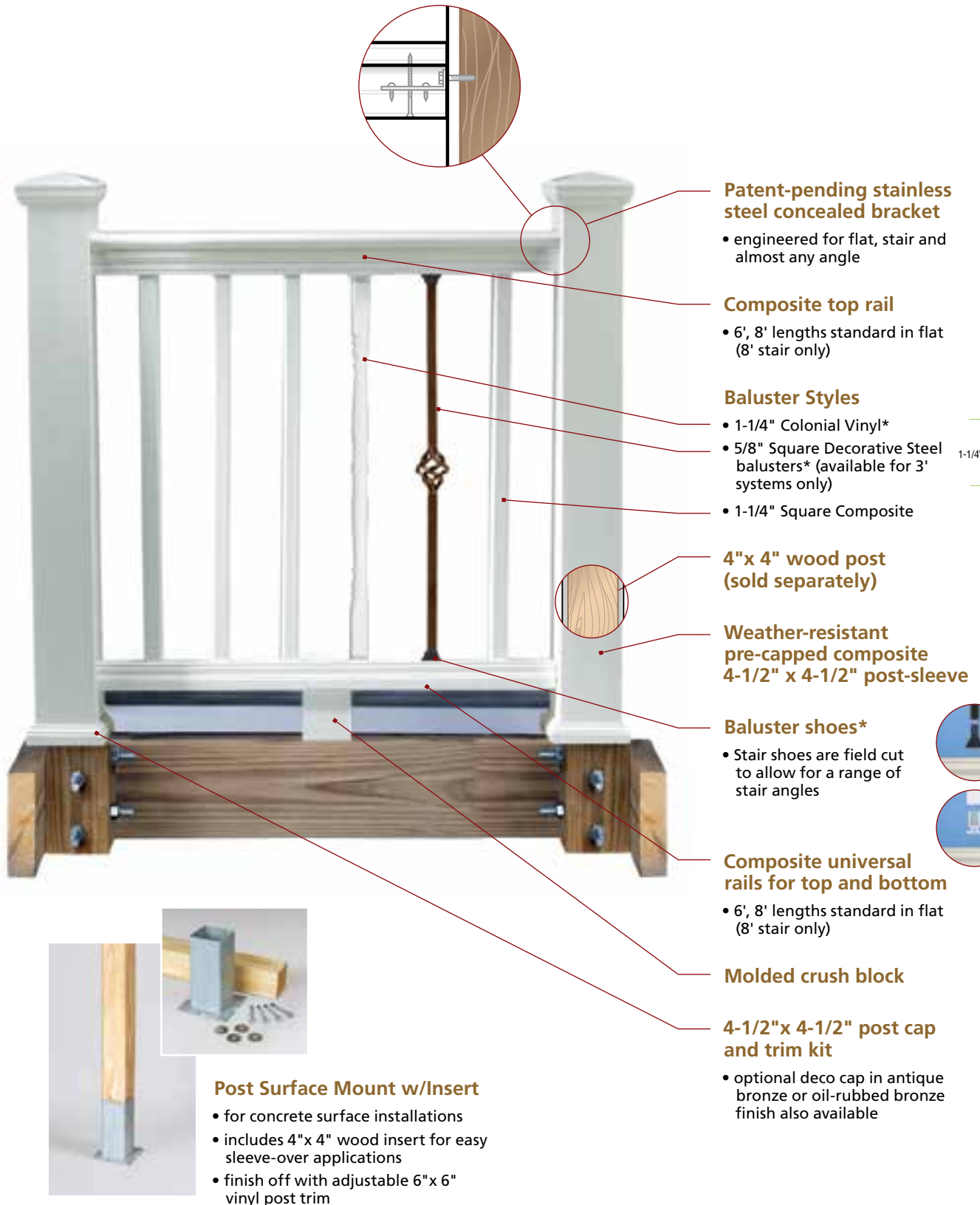

Patent-pending stainless steel concealed bracket

- engineered for flat, stair and almost any angle

Composite top rail

- 6', 8' lengths standard in flat (8' stair only)

Baluster Styles

- 1-1/4" Colonial Vinyl*
- 5/8" Square Decorative Steel balusters* (available for 3' systems only)
- 1-1/4" Square Composite

4"x 4" wood post (sold separately)

Weather-resistant pre-capped composite 4-1/2" x 4-1/2" post-sleeve

Baluster shoes*

- Stair shoes are field cut to allow for a range of stair angles

Composite universal rails for top and bottom

- 6', 8' lengths standard in flat (8' stair only)

Molded crush block

4-1/2"x 4-1/2" post cap and trim kit

- optional deco cap in antique bronze or oil-rubbed bronze finish also available

Post Surface Mount w/Insert

- for concrete surface installations
- includes 4"x 4" wood insert for easy sleeve-over applications
- finish off with adjustable 6"x 6" vinyl post trim

*Refer to product matrix for actual product specifications.

*The Colonial Vinyl and Decorative Steel Balusters install using patented baluster shoe plugs.



Panorama in white with twist balusters in antique bronze finish

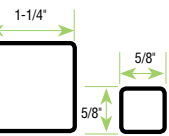

Panorama with vinyl colonial balusters in white



Post sleeve

accommodates standard 4" x 4" wood posts in 40", 54" and 108" lengths

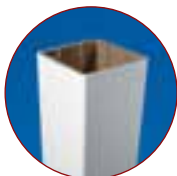

4-1/2" x 4-1/2" square



4-1/2" x 4-1/2" square

Post cap and trim kit



Deco cap accessory snaps onto Panorama post cap. Available in antique bronze and oil-rubbed bronze finish to coordinate with decorative steel balusters.

PVC COMPOSITE RAILING SYSTEM

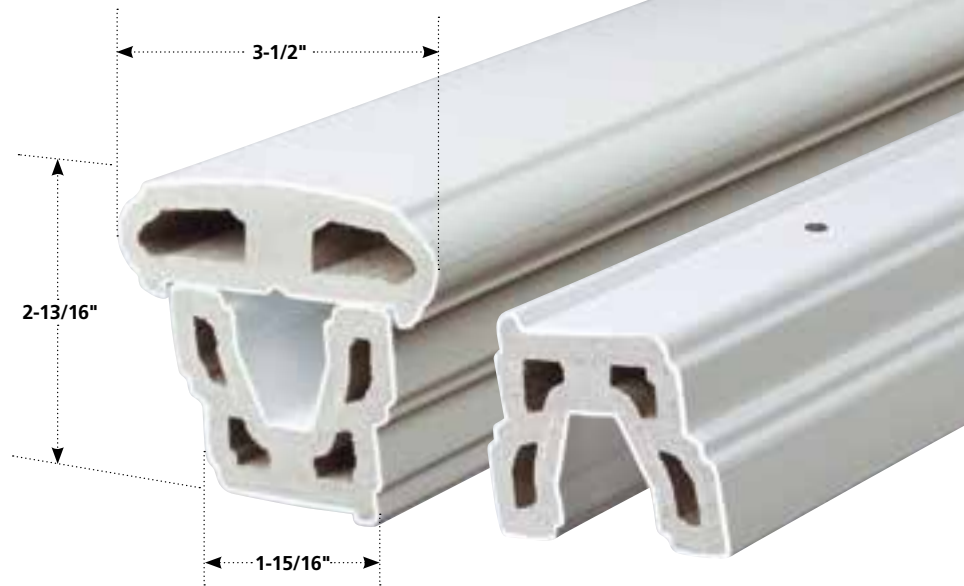

The Panorama® capped composite railing system features a classic painted wood railing design with handcrafted authenticity and true architectural details you won't find on any other composite railing. Panorama's concealed, corrosion-resistant stainless steel hardware provides years of worry-free performance. Panorama integrates with CertainTeed's vinyl accessories, allowing you to create exciting new exterior designs.

- ◆ Classic painted wood style with true architectural details
- ◆ Convenient universal rails for the top and bottom rails, topped off with a decorative top rail cap
- ◆ Concealed external rail-to-post connection and a patent-pending bracket for a seamless appearance on flat, stair, column and 45° applications
- ◆ Corrosion-resistant stainless steel hardware provides safety, security and long-lasting performance
- ◆ Available in two heights and two lengths
- ◆ Choice of three colors and three baluster styles
- ◆ Powder-coated, hot-dipped galvanized steel decorative balusters create a rustic yet customizable system approach for both flat and stair applications
- ◆ Steel balusters available in convenient boxes of 10 per style, for a variety of design possibilities (flat and stair baluster shoes sold separately in bags of 20)
- ◆ Suitable for one- and two-family dwellings/townhouses not more than three stories high
- ◆ Independent tested as designated in report CCRR-0115
- ◆ Class A rating for flame spread
- ◆ 25-year limited warranty with 2-year SureStart™ protection

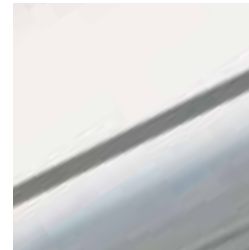

White

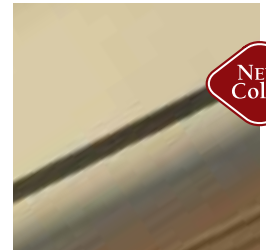

Almond

NEW Color



Clay

NEW Color

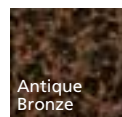

Antique Bronze

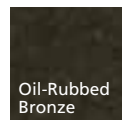

Oil-Rubbed Bronze

Decorative Steel Balusters Finishes: Antique Bronze and Oil-Rubbed Bronze

5/8" square; four styles of powder-coated galvanized steel, pre-cut to 26.75" to yield 36" finished rail height



Straight



Twist



Single Basket



Double Basket

Porch Posts, Wraps & Columns



CertainTeed Structural Porch Posts, Columns and finishing accessories complement any project, no matter which railing style or system is chosen.

- ◆ Pivoting mounting plate for easy installation of porch post
- ◆ Aluminum reinforced for rigidity and strength
- ◆ Load bearing
- ◆ Tie-down connection of porch post eliminates need for separate hurricane tie-down kit
- ◆ No overhead jacking required
- ◆ Class A rating for flame spread

Colonial
5"x 5"
108" length



Colonial
4"x 4"
108" length



Square
5"x 5"
108" length



Tapered Round
column 8" & 10"
108", 120" length



Non-tapered
Round
column 8"
108" length



Square 8"
108" length



Tie-down mounting plates and 4-piece post trim kits for top and bottom included with the post.

Cap and base trim sets sold separately, required for installation. 120" length available for 8" Tapered Round column only.

*Refer to product matrix for actual product specifications.

CERTA-SNAP® POST WRAP



6" x 6" Certa-Snap Wrap in Select Cedar texture with base trim

Designed to coordinate with CertainTeed's vinyl deck and railing products, Certa-Snap Wrap delivers all of the low-maintenance benefits of vinyl posts without having to replace existing wood porch posts.

- ◆ Specially designed for existing wood posts
- ◆ 8-piece system — 4 vinyl post sections plus 4 corner trim pieces
- ◆ Components snap together for easy installation
- ◆ Available 4" x 4" or 6" x 6" in 10' lengths — can be field cut to any length
- ◆ Available in smooth and Select Cedar finish
- ◆ 4-piece post trim for top and bottom sold separately
- ◆ Class A rating for flame spread



White Smooth



Almond Smooth



White Select Cedar



Almond Select Cedar

Installation

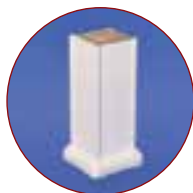

Trim accessory



*Refer to product matrix for actual product specifications.

EverNew® Deck, Railing, Porch Posts, Wraps & Columns (at a glance)

Railing Systems	VINYL			CAPPED COMPOSITE
	Kingston	Oxford	Oxford T-Rail Glass Baluster Infill	Panorama®
BALUSTER SIZE	1-1/2" x 1-1/2"	1-1/4" x 1-1/4"	4" x 3/8"	1-1/4" x 1-1/4" 5/8" x 5/8" Steel
BALUSTER STYLE	Traditional, Square	Colonial, Square	Glass: Clear and Smoked	Square Composite, Colonial Vinyl, Decorative Steel: Antique Bronze, Oil-Rubbed Bronze
BALUSTER SPACING	3-7/16" Flat	3-3/8" Flat	3-7/8" Flat	3-5/8" Flat Composite and vinyl, 3-3/4" Flat Steel
SECTION WIDTH (FLAT NOMINAL)	72", 96" & 120"	72", 96" & 120"	72"	72", 96"
SECTION WIDTH (FLAT ACTUAL)	68-1/2", 92-1/2", 116-1/2"	71-1/2", 95-1/2", 119-1/2"	71-1/2"	67-1/2", 92-1/2"
SECTION HEIGHTS	3' and 3-1/2'	3' and 3-1/2'	3-1/2'	3' and 3-1/2'
RAILS (FLAT SECTIONS)	3-1/4" x 1-1/2" x 68-1/2", 92-1/2" or 116-1/2" Top & Bottom	3" x 3-1/2" x 71-1/2", 95-1/2" or 119-1/2" "T" Shaped Top Rail	3" x 3-1/2" x 71-1/2" "T" Shaped Top Rail	3-1/2" x 2-13/16" x 67-1/2" or 92-1/2" Top Rail
TOP RAIL STYLE	Top Round	"T" Rail	"T" Rail	Classic
BOTTOM RAIL STYLE	Top Round	2 x 4	2 x 4	Classic
REINFORCEMENT	Aluminum Top & Bottom	Aluminum Top & Bottom	Aluminum Top & Bottom	Composite Core
BRACKETS	Aluminum brackets with molded covers for flat, stair, column, 45° and 22-1/2°	Routed post option or aluminum brackets with molded covers for flat, stair, column and 45°	Routed post option or aluminum brackets with molded covers for flat, stair, column and 45°	Patent-pending stainless steel concealed bracket engineered for flat, stair, and almost any angle
COLOR	White, Almond, Clay	White, Almond, Clay	White, Almond, Clay	White, Almond, Clay
CODE LISTING	ESR-1555	CCRR-0187	CCRR-0187	CCRR-0115
APPLICATION	Suitable for 1 and 2-family dwellings and townhouses not more than 3-stories in height	Suitable for residential and commercial applications – including multi-family and over 3-story installation	Suitable for 1 and 2-family dwellings and townhouses not more than 3-stories in height	Suitable for 1 and 2-family dwellings and townhouses not more than 3-stories in height
WARRANTY	Limited Lifetime & Transferable	Limited Lifetime & Transferable	Limited Lifetime & Transferable	25-Year Limited
SURESTART™	5-Year	5-Year	5-Year	2-Year
VALUE	\$-\$	\$\$ - \$\$\$	\$\$\$	\$\$ - \$\$\$

Measurements for all railing systems are from center to center of post. Note actual rail lengths.

Railing Colors	Kingston	Oxford	Panorama
ALMOND	●	●	●
CLAY*	●	●	●
WHITE	●	●	●

* ColorLast® Dark Color Fade Protection - Our acrylic formulation provides superior protection from the harsh rays of the sun, resulting in richer color that retains its vibrant hue for years to come. ColorLast is offered in Clay.

Porch Post Wraps & Columns	VINYL						
	Colonial Post	Colonial Post	Square Post	Square Column	Tapered Round Column	Non-Tapered Round Column	Certa-Snap® Wrap
DIMENSION	5" x 5"	4" x 4"	5" x 5"	8" x 8"	8", 10"**	8"	4" x 4" 6" x 6"
LENGTH	108"	108"	108"	108"	108", 120"***	108"	120"
LOAD BEARING	5000 lbs.	2600 lbs.	5000 lbs.	18000 lbs.	18000 lbs.	18000 lbs.	NA
ALUMINUM REINFORCEMENT	yes	yes	yes	yes	yes	yes	NA
COLOR	White, Almond	White, Almond	White, Clay, Almond	White	White	White	White, Almond, (also features Select Cedar Finish)
INCLUDES MOUNTING PLATE	yes	yes	yes	yes	yes	yes	NA
WARRANTY	Limited Lifetime Transferable	Limited Lifetime Transferable	Limited Lifetime Transferable	Limited Lifetime Transferable	Limited Lifetime Transferable	Limited Lifetime Transferable	Limited Lifetime Transferable
SURESTART™	5-Year	5-Year	5-Year	5-Year	5-Year	5-Year	5-Year

* 8" Tapered Round Column – 7-3/4" tapers to 6-1/8", 10" Tapered Round Column – 9-3/4" tapers to 8-1/8" (taper starts 48" from bottom)

** 120" length available for 8" Tapered Round Column only

Decking	VINYL	CELLULAR PVC	COMPOSITE
	EverNew Vinyl Deck	EverNew LT	EverNew PT
BOARD SIZE (ACTUAL)	1-1/2" x 5-1/2"	1" x 5-1/2"	5.4" x 0.95"
BOARD SPACING	1/8"	1/8-1/4"	3/16"
BOARD SIZE	2" x 6"	5/4 x 6"	5/4 x 6"
BOARD LENGTH (NOMINAL)	12', 16', 20'	12', 16', 20'	12', 16', 20'
BOARD SURFACE	Raised Ridge Tread	Woodgrain, Non-organic	Woodgrain, Non-organic
BOARD COLOR	White, Gray, Almond	Driftwood, Cedar, Jatoba, Spanish Cedar	Rosewood, Ipe, Castle Gray, Tudor Brown
FASCIA SIZE (ACTUAL)	7/8"x6" or 3" or 1-1/2"	1/2" x 11-3/4"	1/2" x 11-3/4", 3/4" x 7-1/4", 3/4" x 11-1/4"
FASCIA LENGTH	8'	12'	12'
FASCIA COLOR	White, Gray, Almond	Driftwood, Cedar, Jatoba, Spanish Cedar	Rosewood, Ipe, Castle Gray, Tudor Brown
FASCIA SURFACE	Smooth	Woodgrain	Woodgrain
JOIST SPACING	16 in.	16 in.	16 in.
SURESTART™	5-Year	NA	NA
WARRANTY	Limited Lifetime	Limited Lifetime, 25-Year Stain & Fade	25-Year Prorated, 25-Year Stain & Fade
CODE	NER-605	CCRR-0152	CCRR-0108
VALUE	\$\$\$	\$\$-\$\$\$	\$\$

Decking Colors	EverNew Vinyl Deck	EverNew LT	EverNew PT
ALMOND	●		
CASTLE GRAY			●
CEDAR		●	
GRAY	●		
DRIFTWOOD		●	
IPE			●
JATOBA		●	
ROSEWOOD			●
SPANISH CEDAR		●	
TUDOR BROWN			●
WHITE	●		

Decking Accessory	VINYL				
	STYLE	DIMENSION	THICKNESS	COLOR	SURFACE
UNDERSHIELD®	Chamfer or Beaded	Chamfer 6" x 16' Beaded 6" x 16' Fascia 4" x 16'	Chamfer .046" Beaded .039" Fascia .05"	Colonial White Sterling Gray Savannah Wicker	Matte



CertainTeed products are designed to work together and complement each other in color and style to give your home a beautiful finished look.



Polymer Shakes & Shingles



Fiber Cement Siding



Fence



Insulated Siding



PVC Exterior Trim & Beadboard



Decking and Railing



Vinyl Siding



Vinyl Carpentry® Trim



Housewrap



Professional: [facebook.com/CertainTeedFreedomofChoice](https://www.facebook.com/CertainTeedFreedomofChoice)
Consumer: [facebook.com/CertainTeedLivingSpaces](https://www.facebook.com/CertainTeedLivingSpaces)

[**Be Certain**] Confidence worth building on.™

ASK ABOUT OUR OTHER CERTAINTEED® PRODUCTS AND SYSTEMS:

ROOFING • SIDING • TRIM • DECKING • RAILING • FENCE • FOUNDATIONS
 GYPSUM • CEILINGS • INSULATION • PIPE

www.certainteed.com <http://blog.certainteed.com>

CertainTeed Corporation
 P.O. Box 860
 Valley Forge, PA 19482

Professional: 800-233-8990
Consumer: 800-782-8777

© 1/14 CertainTeed Corporation, Printed in U.S.A.
 Code No. 40-70-428

