



PARTS LIST

Bifold Hardware	
Multi-Fold Hardware	
Wall Mount Sliding Hardware	
Pocket Door Hardware	
Sliding Bypass Hardware	
Multi-Door Sliding Hardware	

JOHNSON HARDWARE®

Manufacturing World Class
Door Hardware Since 1958

PL-1008

October 1, 2008

For information call: 800-837-5664

To order by Fax: 800-837-4697

Fax: 574-294-4697

e-mail: sales@johnsonhardware.com

Web Site: www.johnsonhardware.com



L.E. Johnson Products, Inc.
2100 Sterling Avenue
Elkhart, IN 46516

INDEX

100FD	2	200SD	15	2200	19
100MD	21	200WM	7	2200F	18
100PD	12	1138	20	2204F	18
100RD	6	1166	19	2222	18
100SD	15	1500	9	2511	11
111FD	3	1510/1511	14	2610F	7
111MD	21	1521/1534	14	2711	11
111PD	13	1560	10	2710	10
111SD	16	1601	5	2800	13
113F	20	1700	4	2800F	14
118F	17	1700RD	6	2850	13
134F	17	1718/34/38	3	7700	22
138F	16	1740	6	7800	22
170A	4	1770	3	88ADJ	22
200FD	2	1825	5	88TEL	22
200MD	21	1838	5	8800	22
200PD	12	2000	8	9000	5
200RD	6	2060	8	9550	5
ANSI Standards					1
Bubble Packed Parts & Accessories					25
Bulk Parts					26, 27, 28
Bulk Tracks					23
Door Displays					22
Folding Door Hardware					2, 3, 4, 5
Merchandiser Centers					24
Multi-Pass Sliding Doors					21
Pocket Door Frames and Hardware					8, 9, 10, 11, 12, 13, 14
Policy Information					28
Room Divider Hardware					6
Sliding Door Hardware					15, 16, 17, 18, 19, 20
Sliding/Folding Door Selection Guide					1
Table Legs					22
Wall Mount Fascia					7

1 American National Standard

ANSI#	Door Wt.	Johnson Series Number	Page
D8611	50 lb. Doors	200FD, 100FD, 111FD	2, 3
D8612	30 lb. Doors	1700, 1718, 1734, 1738, 1770, 1825, 1838	4, 5
D8613	20 lb. Doors	Any of the above	4, 5
D8621	50 lb. Doors	200FD, 100FD, 111FD	2, 3
D8622	30 lb. Doors	1700, 1718, 1734, 1738, 1770, 1825, 1838	4, 5
D8623	20 lb. Doors	Any of the above	2, 3, 4, 5
D8641	50 lb. Doors	200RD, 100RD	6
D8642	30 lb. Doors	Same as above	6
D8651	50 lb. Doors	200RD, 100RD	6
D8652	30 lb. Doors	Same as above	6
D8661	50 lb. Doors	200RD, 100RD	6
D8662	30 lb. Doors	Same as above	6
D86671	80 lb. Door	1500, 2710, 2511, 2711, 2000	8, 9, 10, 11
D86672	60 lb. Door	Same as above	8, 9, 10, 11
D8681	120 lb. Door	200PD, 100PD	12
D8691	60 lb. Door	111PD	13
D8692	40 lb. Door	2800, 2850	13, 14
D8701	80 lb. Door	1500, 2710, 2511, 2711, 2000	8, 9, 10, 11
D8702	60 lb. Door	Same as above	8, 9, 10, 11
D8711	120 lb. Door	1500, 1560, 2710, 2000	8, 9, 10, 11
D8721	60 lb. Door	2511, 2711	11
D8722	40 lb. Door	Any of the above	8, 9, 10, 11
D8731	120 lb. Doors	200SD, 134F, 118F	15, 16
D8741	80 lb. Doors	Same as above	15, 16
D8742	40 lb. Doors	1138, 1166, 2200	19, 20
D8751	80 lb. Doors	134F, 138F, 118F	17, 18
D8751	40 lb. Doors	2200F, 2204F	18, 19
D8761	80 lb. Doors	Not Available	
D8762	40 lb. Doors	2222	18
D8771		2155	28
D0781		14US3, 15US3, 20, 21, 30, 35, 40	26
D1791	Surface Pull	Not Available	
D2801		150	25, 26
D0811		2118, 2133, 2134, 2135, 2138, 2035, 2034	27, 28
D0821		1521	14

Sliding Door Hardware Selection Guide

DOOR WEIGHT	DOOR THICKNESS			
	3/4"	1 1/8"	1 3/8"	1 3/4"
Up To				
50#	1166	118F (C)	1138	
	2200		1166/2200	134F (C)
	2204F		2200F 1 WHL	
			138F (C)	
75#		118F (C)	2200F 2 WHL	134F (C)
			138F (C)	
125#	111SD(C)	110SD(C)	138F (C)	134F (C)
200#			138F* (C)	134F* (C)
300#			200SD (C)	200SD (C)

(C) Designates Commercial Grade *Use With 1125 Ball Bearing Hanger

FINISHED OPENING HEIGHTS

111SD, 118F = Door Height Plus 2-1/8"
 100SD, 134F & 138F = Door Height Plus 2-3/8"
 (all Other Residential Sets = Door Height Plus 1-3/4")

200SD = Door Height Plus 3-3/4"

FINISHED OPENING WIDTHS (ALL SERIES)

2 DR. - Door Width x 2 Minus 1"
 3 DR. - Door Width x 3 Minus 2"
 4 DR. - Door Width x 4 Minus 2"

SINGLE TRACK

2800 Aluminum - Doors Up To 50# 2850 Steel - Doors Up To 50#
 100 Aluminum - Doors Up To 125# 100 w/1125* - Doors Up To 200#
 111 Aluminum - Doors Up To 80# 111 w/1025* - Doors Up To 150#
 200 - Doors Up To 300#

SPECIALTY TRACK

(1-3/8" - 1-3/4") 2610F - 125# Doors - Wall Mount
 2800F - 75# Doors Double Fascia

Folding Door Selection Guide

DOOR PANEL WEIGHT	MAX DOOR WIDTH	DOOR THICKNESS		
		1 1/8"	1 3/8"	1 3/4"
Up to	24"	1825	1825	
30#		1838	1838	
		1700	1700	1700
		1601	1601	1601
40#	24"	1700	1700	1700
50#	24"	111FD	111FD	111FD
75#	24"		100FD	100FD
125#	48"		200FD	200FD

SERIES	DESCRIPTION	FINISHED OPENING HEIGHT		FINISHED OPENING WIDTH	
		Door Height Plus	2 Door Plus	4 Door Plus	4 Door Plus
1601	100% Full Access	+5/8"	+7/16"	+5/8"	
1700	Top Hung	+2"	+9/16"	+13/16"	
1825	Commodity Set	+1 3/4"	+9/16"	+13/16"	
1838	Commodity Set	+1 3/4"	+9/16"	+13/16"	
111FD	Light Commercial	+2 3/4"	+9/16"	+13/16"	
100FD	Commercial	+2 7/8"	+9/16"	+13/16"	
200FD	Heavy Commercial	+4 1/4"	+11/16"	+1"	

NOTE: Door Panel Width Not To Exceed 24" - Except 200FD 48"

MULTIFOLD SHUTTER AND ROOM DIVIDER HARDWARE AVAILABLE

- 1740 - 3/4" Shutter
- 1700RD - 1 1/8" To 1 3/8" Doors To 20# Panels (Max. 24" Panels)
- 100RD - 1 3/8" To 1 3/4" Doors To 50# Panels (Max. 24" Panels)
- 200RD - 1 1/8" To 1 3/4" Doors To 75# Panels (Max. 36" Panels)

POCKET DOOR SELECTION GUIDE

2511 Series Up To 80# Doors - *Up To 150# Doors - *With 1025 Ball Bearing Rollers
 1500 Series Up To 125# Doors - *Up To 200# Doors - *With 1125 Ball Bearing Rollers
 2000 Series Up To 300# Doors

ROUGH OPENINGS Width: 2 x Door Width Plus 1"

Height: 6' 8" = 84 1/2" - 7' 0" = 88 1/2" - 8' 0" = 100 1/2"

For 1 3/4" Thick Doors, Use The 1575PPK3 Adaptor Kit

Note: 1500/1560/2000 Series Available Up To 5' Wide and 9' High

Note: 1560 Series Door Ht. + 5" Note: 2000 Series Door Ht. + 6 3/4"

Note: 2060 Series Door Ht. + 7 1/4"

ORDERING DATA

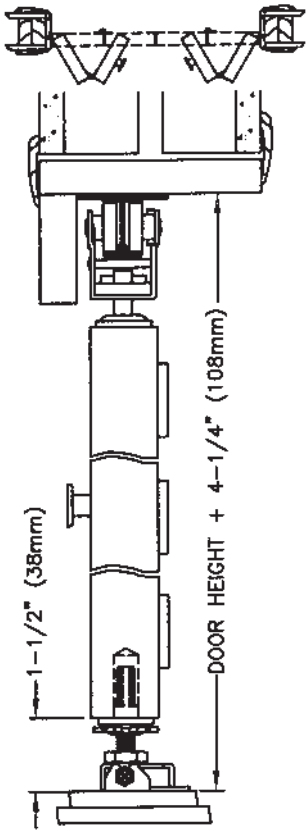

200FD

Order No.	Opening	LBS./CASE
200FD482	48" 2 Door	
200FD602	60" 2 Door	Bulk
200FD722	72" 2 Door	5/CT.
200FD962	96" 2 Door	6/1
200FD484	48" 4 Door	8/1
200FD604	60" 4 Door	
200FD724	72" 4 Door	
200FD964	96" 4 Door	

Order No.	PKG.	BULK
200FD482		
200FD602		
200FD722		
200FD962		
200FD484		
200FD604		
200FD724		
200FD964		
2003 (Pair)		

A premium commercial bifold hardware for 12"-48" panels up to 9'0" high. Heavy duty I-beam track with positive pivot lock, top hung, four wheel (1" dia.) ball bearing hangers, heavy duty bottom pivot, floor bracket with screw adjusting bottom pivot socket. Brass-tone steel parts. *2003 Hinges not included, order separately.*

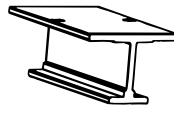

200

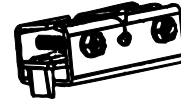

2010

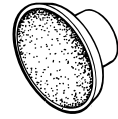

37



2001



2011



2007



2002

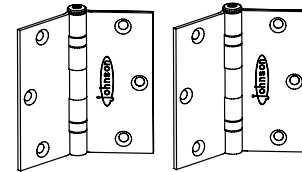

2003

Ball Bearing Hinge



1712 WRENCH

Finishes

- 2003US32 Bright Brass
- 2003US52 Antique Brass
- 200326D2 Satin Chrome

ORDERING DATA

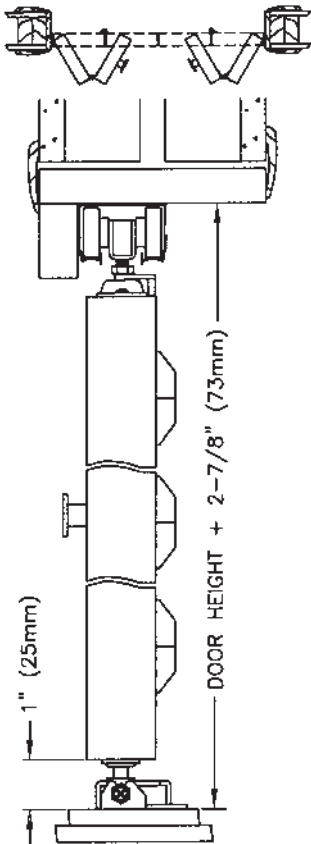

100FD

Order No.	Opening	LBS./CASE
100FD362	36" 2 Door	15/5
100FD484	48" 4 Door	25/5
100FD604	60" 4 Door	26/5
100FD724	72" 4 Door	27/5
100FD964	96" 4 Door	33/3

Order No.	PKG.	BULK
100FD362		
100FD484		
100FD604		
100FD724		
100FD964		

Bulk
25/CT.

An excellent commercial bifold hardware for 12"-24" panels up to 9'0" high. Convex rail aluminum track with positive pivot lock, top hung, three wheel (1" dia.) ball bearing hangers, non-mortise lift off hinges. Floor bracket has a screw adjusting bottom pivot socket. Brass-tone steel parts.



100



1125



107



1706



1606



1155



33

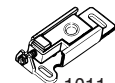

1011

ORDERING DATA

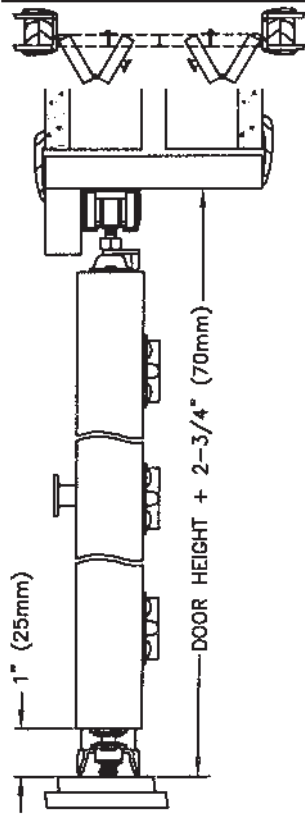

111FD

Order No.	Opening	LBS./CASE
111FD362	36" 2 Door	11/5
111FD484	48" 4 Door	18/5
111FD604	60" 4 Door	19/5
111FD724	72" 4 Door	20/5
111FD964	96" 4 Door	24/3

Order No.	PKG.	BULK
111FD362		
111FD484		
111FD604		
111FD724		
111FD964		

Bulk
25/CT.

A superior light commercial bifold hardware for 12"-24" panels up to 9'0" high. Convex rail aluminum track, top hung, three wheel (3/4" dia.) hangers, four way adjustable jamb bracket, shock absorbing "breathing" hinges self locate and automatically align to door. Brass-tone steel parts.

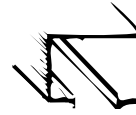

111



1711



1707



1155



118



1020

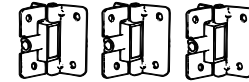

1703



33

1770 Side Mount Bifold Hardware
for 3/4" panels to 40 lbs.

ORDERING DATA

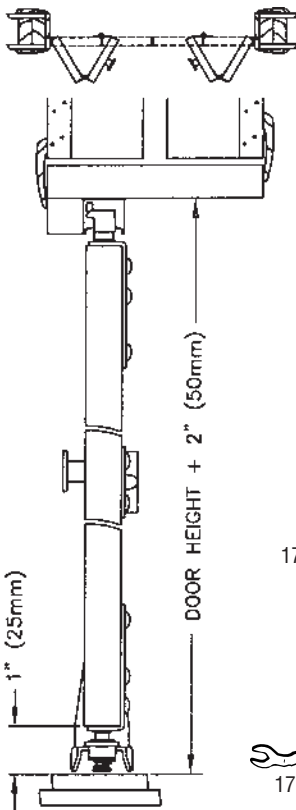

1770

Order No.	Opening	LBS./CASE
1770243H	24" 2 Door	
1770303H	30" 2 Door	
1770363H	36" 2 Door	
1770486H	48" 4 Door	Bulk Only
1770606H	60" 4 Door	25/CT.
1770726H	72" 4 Door	
1770966H	96" 4 Door	

Order No.	PKG.	BULK
1770243H		
1770303H		
1770363H		
1770486H		
1770606H		
1770726H		
1770966H		

Same features as 1718/1734/1738 but for 3/4" doors only. Pivot and guide plate is 1-1/4" longer than 1718/1734/1738 plates. Also available in white (bulk only).

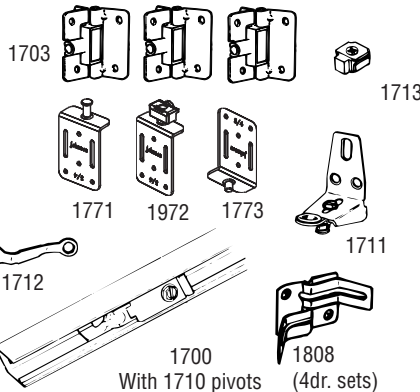

1718/1734/1738 Side Mount Bifold Hardware for
panels to 40 lbs. 1734=3/4", 1718=1-1/8", 1738=1-3/8"

ORDERING DATA

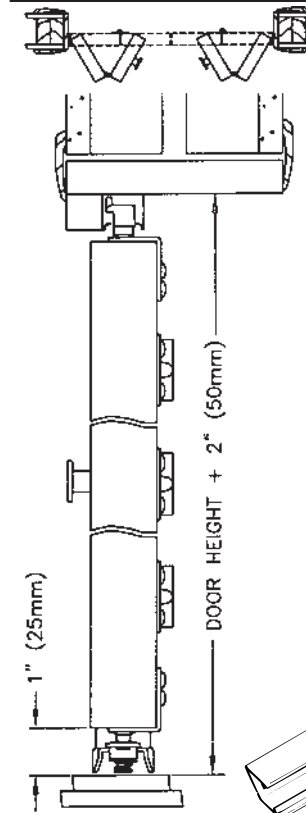

1738

Specify	Opening	LBS./CASE
	24" 2 Door	
	30" 2 Door	
1734=3/4"	36" 2 Door	Bulk Only
1718=1-1/8"	48" 4 Door	
1738=1-3/8"	60" 4 Door	25/CT.
	72" 4 Door	
	96" 4 Door	

Specify	Opening	BULK
	24" 2 Door	
	30" 2 Door	
1734=3/4"	36" 2 Door	
1718=1-1/8"	48" 4 Door	
1738=1-3/8"	60" 4 Door	
	72" 4 Door	
	96" 4 Door	

Same features as 1700 series, except hardware is mounted to back side of door. Side mount plates can be adjusted if opening is slightly out of square. Top pivot and guide must be kept parallel with track. Also available in white (bulk only).

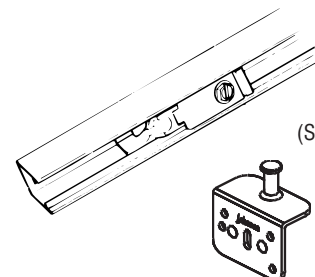

(See 1770 for parts)

1724

170A Top Mount Bifold Hardware for 3/4" to 1-3/4" panels to 40 lbs.

ORDERING DATA

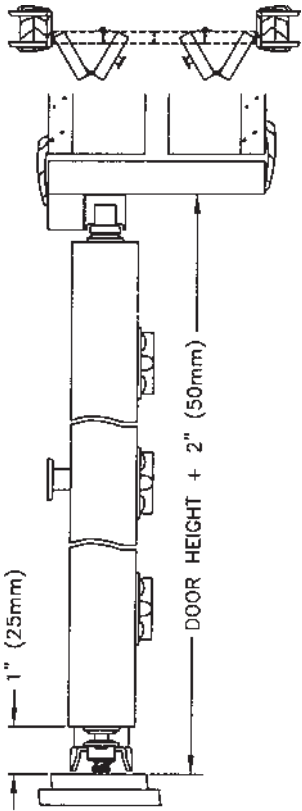

170A

Order No.	Opening	LBS./CASE
170A243H	24" 2 Door	9/5
170A303H	30" 2 Door	10/5
170A363H	36" 2 Door	11/5
170A486H	48" 4 Door	17/5
170A606H	60" 4 Door	18/5
170A726H	72" 4 Door	20/5
170A966H	96" 4 Door	23/5

Order No.	PKG.	BULK
170A243H		
170A303H		
170A363H		
170A486H		
170A606H		
170A726H		
170A966H		

Bulk Only
25/CT.

A premium aluminum residential bifold hardware. Top hung hardware allow doors to hang naturally. Automatic top of door spacing eliminates gaps. Smooth nonbinding operation. Aluminum track with positive pivot lock. Surface mounted pivots and guides (no hole drilling). Four way adjustable jamb bracket, shock absorbing "breathing" hinges self locate and automatically align to door. Brasstone steel parts.

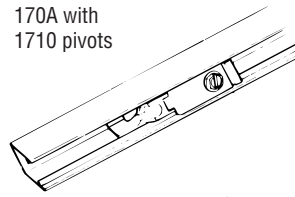

1808 (4 dr. sets)

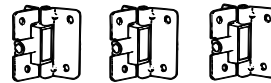

1703



1711



1712



1713

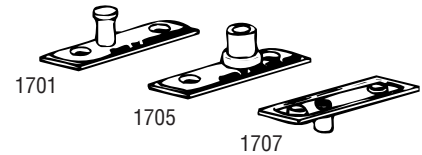

1701

1705

1707

1700 Top Mount Bifold Hardware for 3/4" to 1-3/4" panels to 40 lbs.

ORDERING DATA

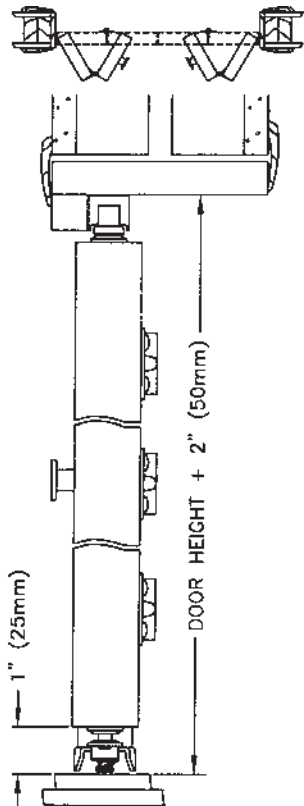

1700

Order No.	Opening	LBS./CASE
1700243H	24" 2 Door	9/5
1700303H	30" 2 Door	10/5
1700363H	36" 2 Door	11/5
1700486H	48" 4 Door	17/5
1700606H	60" 4 Door	18/5
1700726H	72" 4 Door	20/5
1700966H	96" 4 Door	23/5

Order No.	PKG.	BULK
1700243H		
1700303H		
1700363H		
1700486H		
1700606H		
1700726H		
1700966H		

Bulk Only
25/CT.

Same features as the 170A, but with woodtone steel track.

Also available in white. (Bulk only)

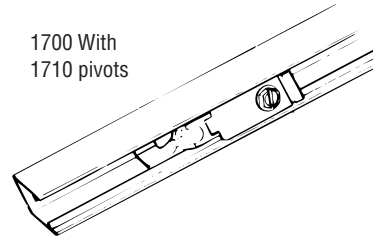

1700 With
1710 pivots

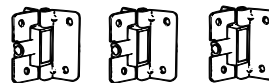

1703



1711



1808 (4 dr. sets)



33



1712



1713

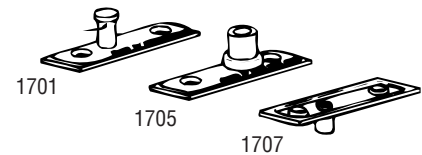

1701

1705

1707

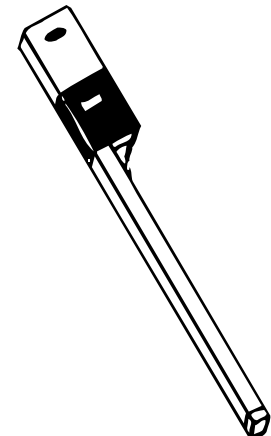

1825 Bifold Hardware for 1-1/8" to 1-3/4" panels to 35 lbs. (7/16" pivot/guide hole)

ORDERING DATA

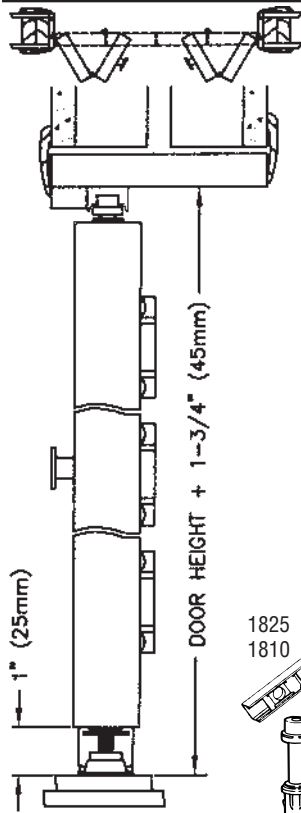

Order No.	Opening	LBS./CASE
1825243H	24" 2 Door	---
1825303H	30" 2 Door	---
1825323H	32" 2 Door	---
1825363H	36" 2 Door	8/5
1825486H	48" 4 Door	12/5
1825606H	60" 4 Door	13/5
1825726H	72" 4 Door	15/5
1825966H	96" 4 Door	17/5

Order No.	PKG.	BULK
1825243H	(BULK)	
1825303H	(25/ctn)	
1825323H		
1825363H		
1825486H		
1825606H		
1825726H		
1825966H		

Low profile woodtone steel track. Pivots and guides have a needle bearing surface to minimize friction. Jamb bracket has an adjustable bottom pivot bearing socket. Hinges are self locating and automatically align to door. Brass-tone steel parts.

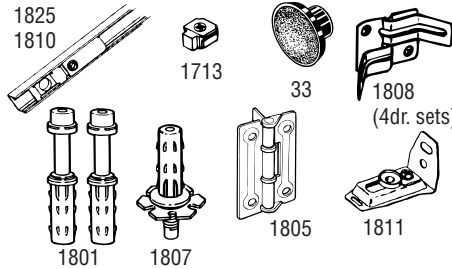

1825

1838 Bifold Hardware for 1-1/8" to 1-3/4" panels to 30 lbs. (3/8" pivot/guide hole)

ORDERING DATA

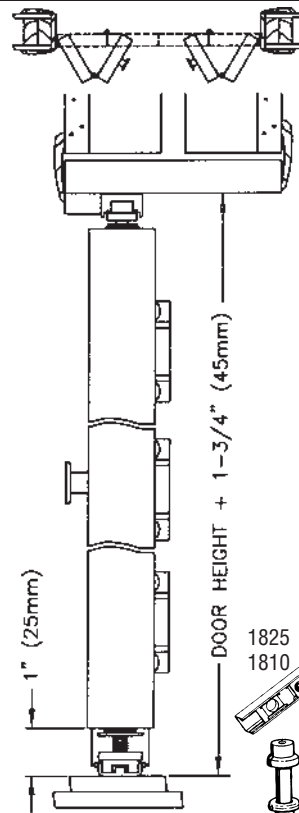

Order No.	Opening	LBS./CASE
1838243H	24" 2 Door	---
1838303H	30" 2 Door	---
1838323H	32" 2 Door	Bulk Only
1838363H	36" 2 Door	25/CT.
1838486H	48" 2 Door	
1838606H	60" 4 Door	
1838726H	72" 4 Door	
1838966H	96" 4 Door	

Order No.	PKG.	BULK
1838243H		
1838303H		
1838323H		
1838363H		
1838486H		
1838606H		
1838726H		
1838966H		

Low profile white steel track. Pivots and guides have a needle bearing surface to minimize friction. Jamb bracket has positive positioning bottom pivot bearing socket. Hinges are self locating and automatically align to door. Brass-tone steel parts.

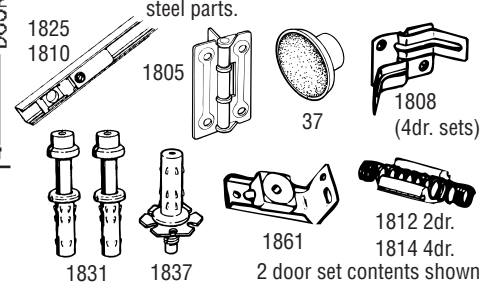

1838

1601 Full Access Bifold Hardware for 3/4" or 1-3/4" panels to 30 lbs.

ORDERING DATA

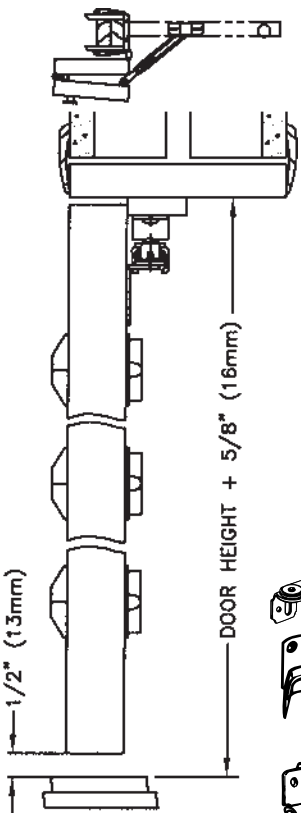

Order No.	Panel Size	LBS./CASE
1601218P	11-3/4"-18"	8/5
1601824P	18" - 24"	10/5

Optional size available for 9"-12" panels. Bulk only, consult factory.

Order No.	PKG.	BULK
1601218P		
1601824P		

Unique bifold provides full jamb to jamb access. Doors fold 180 degrees and lay flat against wall. No top track. Comes with woodtone non-mortise lift off jamb hinges (mortised butts can be used at jamb). Woodtone Control Arm, brass-tone steel parts.

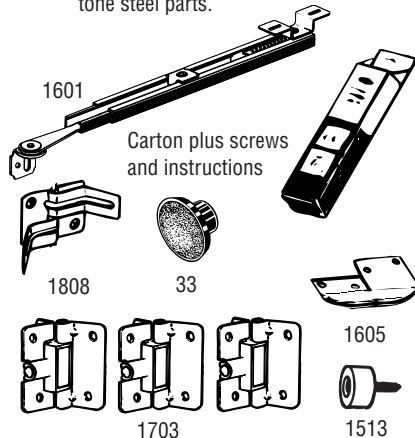

1601

9000 Closet Rod System

ORDERING DATA

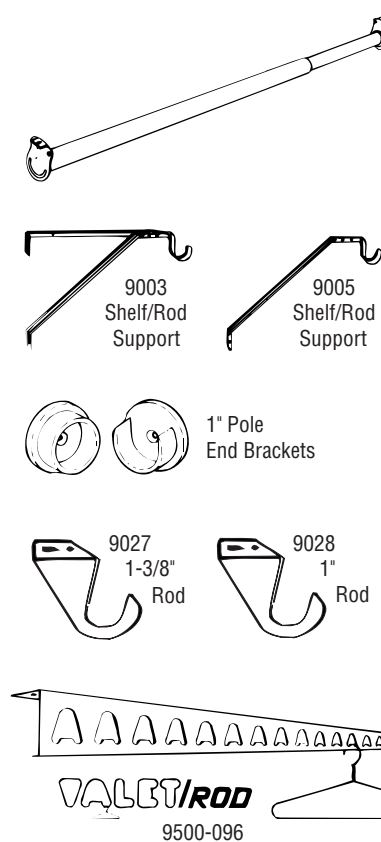

Order No.	Size	LBS./CASE
9018-30P	18"-30"	11/10
9030-48P	30"-48"	18/10
9048-72P	48"-72"	24/10
9072-96P	72"-96"	30/10
9072120P	72"-120"	38/10
9096144P	96"-144"	23/5
9003WHEN	----	17/20
9005WHEN	----	11/20
9027PLBG	----	4.5/20
9028PLBG	----	4.1/20
9030PLBG	----	4/100
9030PPK3	----	1.2/10
9500-096	96"	32/20

Order No.	PKG.	BULK
9018-30P		
9030-48P		
9048-72P		
9072-96P		
9072120P		
9096144P		
9003WHEN		
9005WHEN		
9027PLBG		
9028PLBG		
9030PLBG		
9030PPK3		
9500-096		

Bulk 15/CT. 22 gauge welded seam tubing plated bright zinc. Rods "Snap" into end brackets, heavy 12 gauge white powder coated shelf and rod supports.

200RD Multi Folding Hardware for 1-1/8" to 1-3/4" panels to 75 lbs.



100RD Multi Folding Hardware for 1-1/8" to 1-3/4" panels to 50 lbs.



ORDERING DATA

Specify		LBS./CASE
200	Track Only	
2015BS-A	Basic Set	3/1
2002PLBG	Hanger	25/35
209PIV-S	Top & Bottom Pivot Set	1.8/1

Specify	PKG.	BULK
200		see pg. 23
2015BS-A		
2002PLBG		
209PIV-S		
2003 Hinge	PR	

Hardware for panels 12"-36" up to 9'0" high. Heavy duty I-beam track with positive pivot lock, top hung, four wheel (1" dia.) ball bearing hangers, heavy duty bottom pivot, floor bracket with screw adjusting bottom pivot socket. Brass-tone steel parts. (Maximum: Six doors each way.) 2003 Hinges not included, order separately.

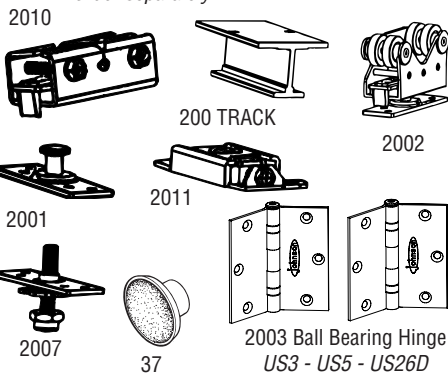
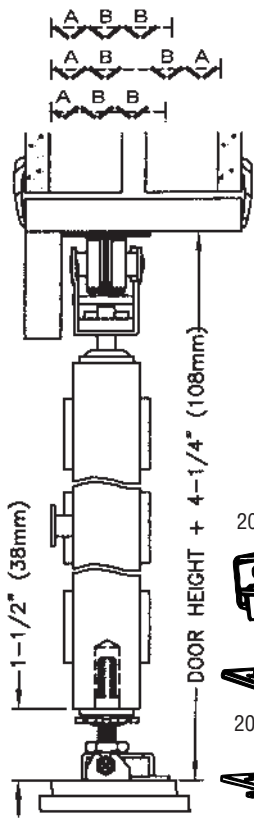

200RD

ORDERING DATA

Specify		LBS./CASE
100	Track Only	
1015BS-A	Basic Set	1.5/1
1030AOSB	Add-On-Set "B"	1.4/1
1019PIVS	Pivot Set	1.7/1

Specify	PKG.	BULK
100		see pg. 23
1015BS-A		
1030AOSB		
1019PIVS		

Hardware for panels 12"-24" up to 9'0" high. Convex rail aluminum track with positive pivot lock, top hung, three wheel (1" dia.) ball bearing hangers, non-mortise lift off hinges. Floor bracket has a screw adjusting bottom pivot socket. Brass-tone steel parts. (Maximum: Six doors each way.)

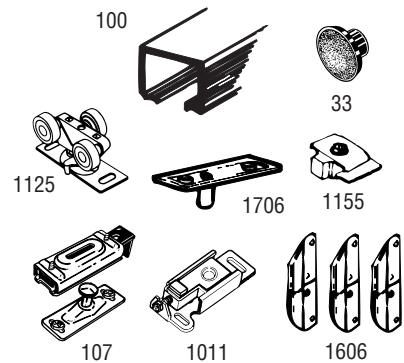
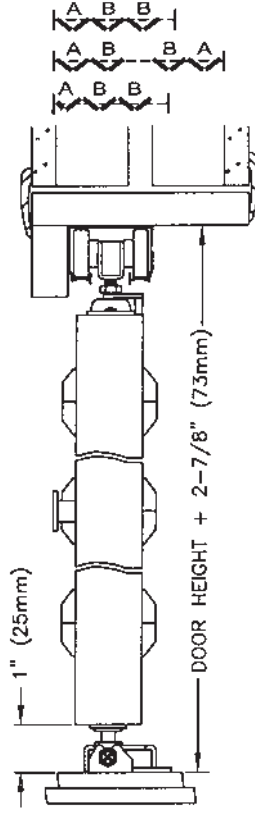

100RD

1740 Shutter Hardware for 3/4" to 1-1/8" wood shutters to 15 lbs.



ORDERING DATA

Specify		LBS./CASE
170A	Track Only	
1740BS-A	Pivot Set	5.5/10
1740-AOS	Add-on-Set	2.4/10
1743PPK3	Hinge	1.3/10

Specify	PKG.	BULK
170A		see pg. 23
1740BS-A		
1740-AOS		
1743PPK3		

Hardware for shutters 6" to 18" up to 6'8" high. Aluminum track with positive pivot lock, top hung, surface mounted pivots/hangers, four wheel (7/16" dia.) hangers, low profile combination jamb/floor bracket, non-mortise lift off shutter hinges. Brass-tone steel parts. (Maximum: Six doors each way.)

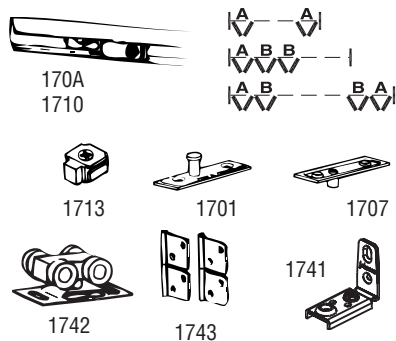
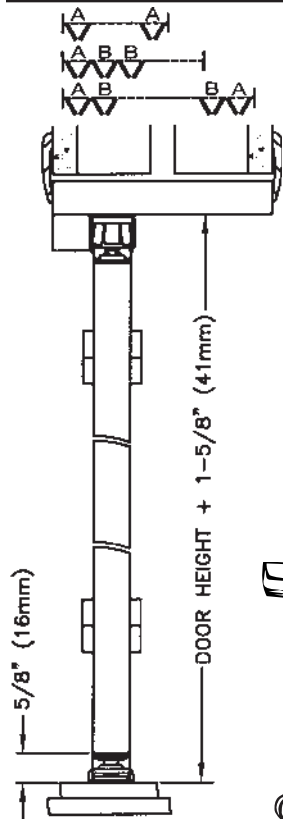

1740RD

1700RD Multi Folding Hardware for 3/4" to 1-3/8" panels to 15 lbs.



ORDERING DATA

Specify		LBS./CASE
170A	Track Only	
1715BS-A	Basic Set "A"	1/1
1725AOSB	Add-On Set "B"	1.2/1
1759PIVS	Pivot Set Only	3.7/10

Specify	PKG.	BULK
170A		see pg. 23
1715BS-A		
1725AOSB		
1759PIVS		

Hardware for panels 9" to 18" up to 6'8" high. Aluminum track with positive pivot lock, top hung, surface mounted pivots/hangers, four way adjustable jamb bracket, four wheel (7/16" dia.) hanger, non-mortise lift off hinges. Brass-tone steel parts. (Maximum: Six doors each way.)

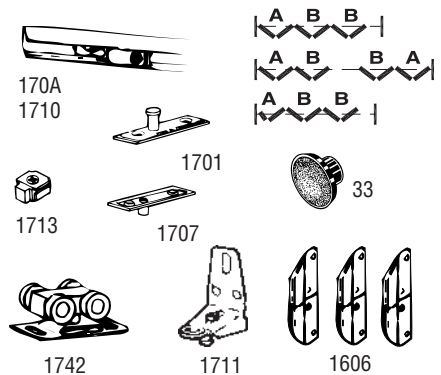
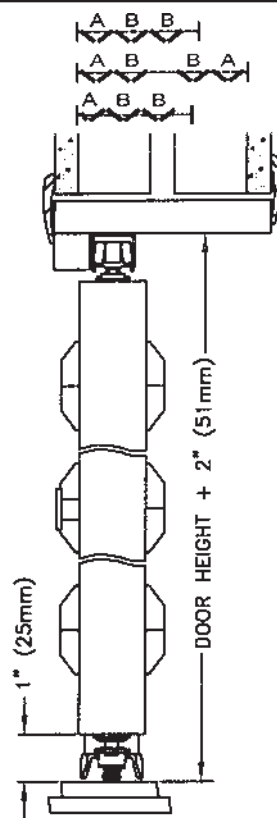

1700RD

ORDERING DATA

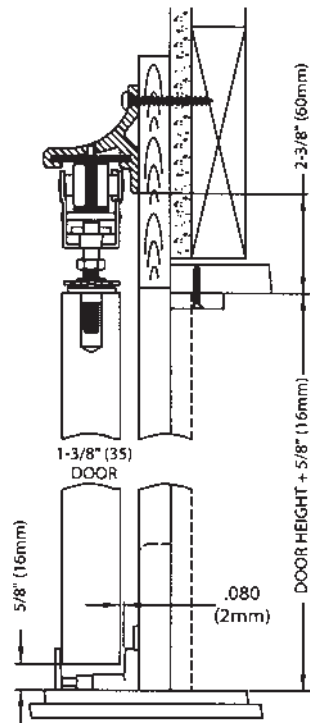

200WM

Order No.	Door Size	LBS./CASE
200WM481	(One 2'0" Door)	7/1
200WM601	(One 2'6" Door)	8/1
200WM721	(One 3'0" Door)	9/1
200WM961	(One 4'0" Door)	11/1

Order No.	PKG.	BULK
200WM481		Bulk 5/CT.
200WM601		
200WM721		
200WM961		

The 200 WM is a heavy-duty wall mounted sliding door hardware set for interior residential or commercial applications. The 200 WM is ideally suited for use when traditional pocket doors cannot be cost effectively or structurally installed. The 200WM features a thick walled precision extruded aluminum I-beam track and heavy-duty extruded aluminum mounting brackets that can be positioned along the track to anchor into wall studs. Four-wheeled ball bearing hangers assure smooth operation and removable hanger plates allow for easy door installation and removal. Two different door guides are supplied with the hardware set for maximum installation flexibility. 14 - 16 gauge zinc dichromate plated steel parts. Track lengths are available up to 192" (4877 mm).

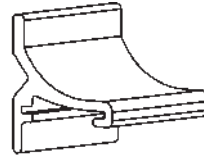

2006

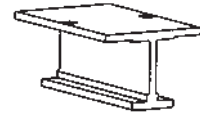

200 Track

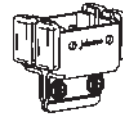

2055 Stop

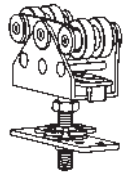
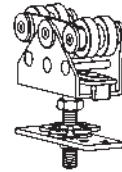

2020 Hanger
2021 Door Plate

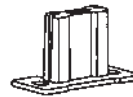

2031 Door
Guide

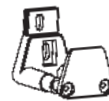

12 Guide

ORDERING DATA

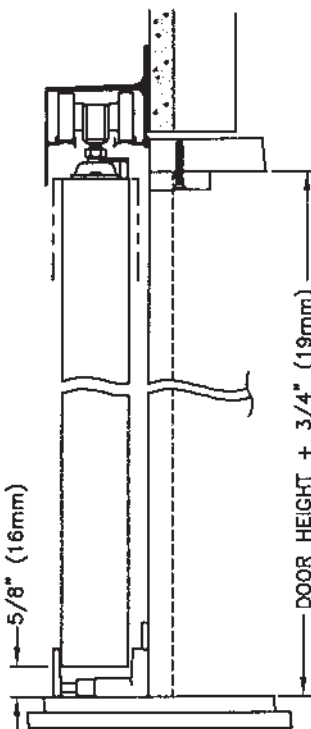

2610F

Order No.	Door Size	LBS./CASE
2610F481	(One 2'0" Door)	21/5
2610F601	(One 2'6" Door)	25/5
2610F721	(One 3'0" Door)	30/5
2610F961	(One 4'0" Door)	38/5

Order No.	PKG.	BULK
2610F481		Bulk 20/CT.
2610F601		
2610F721		
2610F961		

A unique surface mounted hardware for open pocket doors. Use when normal pocket doors can not be used. Aluminum track with convex rails, jump proof three wheel (1" dia.) hangers assure a smooth quiet operation, wall mount guide. Brass-tone steel parts. Optional hanger #1125 available for doors up to 200 lbs.

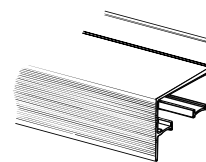

2610F

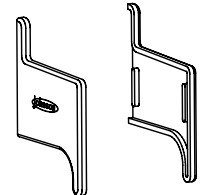

2680 End Caps

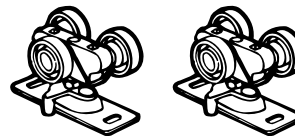

1120



1155

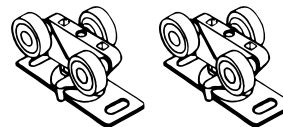

Optional Hangers 1125
(Bulk only.)



12 Guide

ORDERING DATA

For 2 x 4 construction. Aluminum "I" Beam track, smooth quiet operation, rust resistant steel reinforced wood split studs, jump proof 4 wheel ball bearing wheel (1" dia.) Hangers, self-adjusting floor anchors, 2'6" and 3'0" headers marked to cut to small door sizes. Brass-tone steel parts.

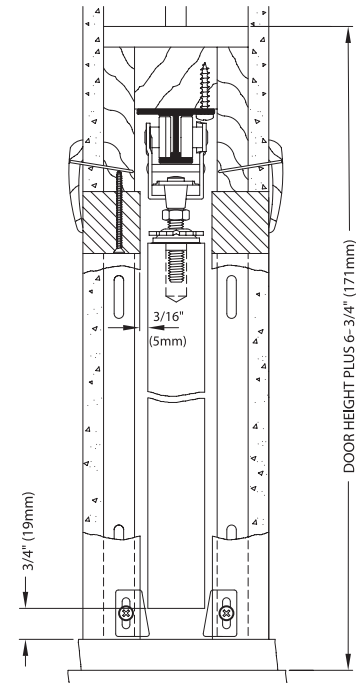
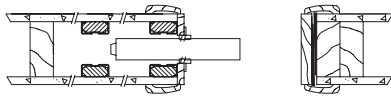

2000

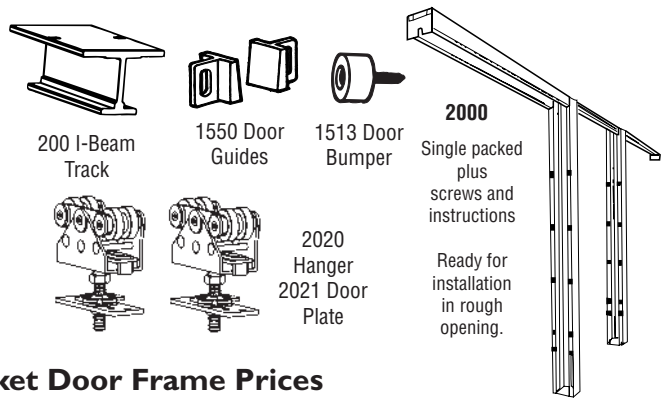

2000 Series Pocket Door Frame Prices

Order No.		
202668PF* (For doors up to 30" wide x 80" tall)	
203068PF* (For doors up to 36" wide x 80" tall)	
204068PF (For doors up to 48" wide x 80" tall)	
205068PF (For doors up to 60" wide x 80" tall)	
202670PF* (For doors up to 30" wide x 84" tall)	
203070PF* (For doors up to 36" wide x 84" tall)	
204070PF (For doors up to 48" wide x 84" tall)	
205070PF (For doors up to 60" wide x 84" tall)	
202680PF* (For doors up to 30" wide x 96" tall)	
203080PF* (For doors up to 36" wide x 96" tall)	
204080PF (For doors up to 48" wide x 96" tall)	
205080PF (For doors up to 60" wide x 96" tall)	
202690PF* (For doors up to 30" wide x 108" tall)	
203090PF* (For doors up to 36" wide x 108" tall)	
204090PF (For doors up to 48" wide x 108" tall)	
205090PF (For doors up to 60" wide x 108" tall)	
2050PLBG	Converging Door Kit 10ct/10wt.....	

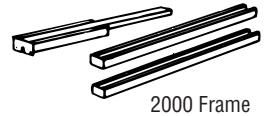

2000 Frame

- * 2'6" and 3'0" Frames are marked for cutting to smaller sizes.
- ✓ All the features of the 1500 Series.
- ✓ For doors up to 300 lbs.
- ✓ 2000 Frames can accommodate doors up to 1 3/4" thick. 1575PPK3 1 3/4" door adapter included w/all frames.

2060 Pocket Door Frame for 1-1/8" to 2-1/4" doors to 300 lbs. each. (2" x 6" stud wall)

ORDERING DATA

Order No.	Door Size	LBS./CASE
20602668	2'6" x 6'8" Door	52/1
	<i>(Marked for cutting 2/0 and 2/4 door)</i>	
20603068	3'0" x 6'8" Door	55/1
	<i>(Marked for cutting to any size door)</i>	
2050PLBG	Converging. Dr. Kit	10/10

Order No.	PKG.
20602668	
20603068	
2050PLBG	

For 2 x 6 construction, the 2060 features aluminum I beam track with 4-wheel ball bearing hangers. Also, rust-resistant 16 gage all-steel uprights that make the walls as strong as a stud wall. The 2/6 and 3/0 frames are marked for cutting to smaller door sizes.

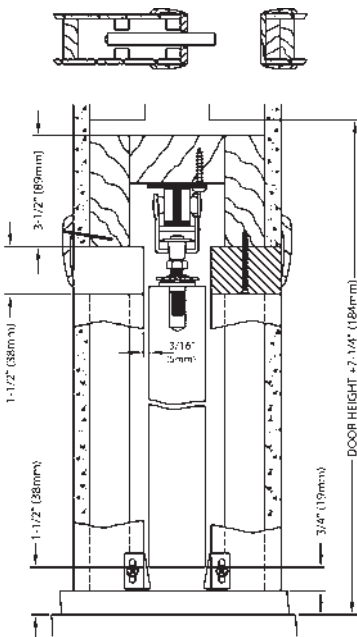

2060

Ready for installation in rough opening.

2060 Series Pocket Door Frame Prices

Order No.		
20602668 (For doors up to 30" wide x 80" tall)	
20603068 (For doors up to 36" wide x 80" tall)	
20604068 (For doors up to 48" wide x 80" tall)	
20605068 (For doors up to 60" wide x 80" tall)	
20602670 (For doors up to 30" wide x 84" tall)	
20603070 (For doors up to 36" wide x 84" tall)	
20604070 (For doors up to 48" wide x 84" tall)	
20605070 (For doors up to 60" wide x 84" tall)	
20602680 (For doors up to 30" wide x 96" tall)	
20603080 (For doors up to 36" wide x 96" tall)	
20604080 (For doors up to 48" wide x 96" tall)	
20605080 (For doors up to 60" wide x 96" tall)	
20602690 (For doors up to 30" wide x 108" tall)	
20603090 (For doors up to 36" wide x 108" tall)	
20604090 (For doors up to 48" wide x 108" tall)	
20605090 (For doors up to 60" wide x 108" tall)	

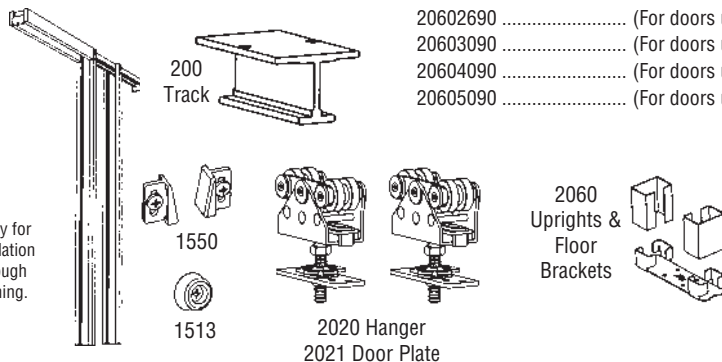

- ✓ All the features of the 2000 Series.
- ✓ All frames fit 2" x 6" stud walls
- ✓ 16 Gage steel studs make wall strong as stud walls.
- ✓ 2060 Frames can accommodate doors up to 2 1/4" thick.



ORDERING DATA

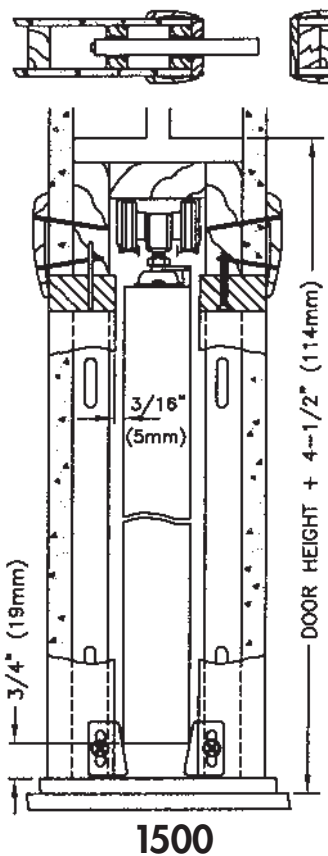

Order No.	Door Size	LBS./CASE
152068PF	2'0" x 6'8" Door	28/1
152468PF	2'4" x 6'8" Door	29/1
*152668PF	2'6" x 6'8" Door	30/1
152868PF	2'8" x 6'8" Door	30/1
*153068PF	3'0" x 6'8" Door	30/1
1555PPK3	Conv. Dr. Kit	3/10
1575PPK3	1-3/4" Dr. Adpt.	3/10
1500PPK3	Extra Hardware Set	5/10

Order No.	PKG.	HD/w1125**
152068PF		
152468PF		
152668PF		
152868PF		
153068PF		

Orders in multiples of 49 frames will be skidded - N/C

- 1555PPK3
- 1575PPK3
- 1500PPK3

For 2 x 4 construction. Removable aluminum track with convex rails for smooth quiet operation, rust resistant steel reinforced wood split studs, jump proof three wheel (1" dia.) hangers, self-adjusting floor anchors, 2'6" and 3'0" headers marked to cut to smaller door sizes. Brass-tone steel parts.

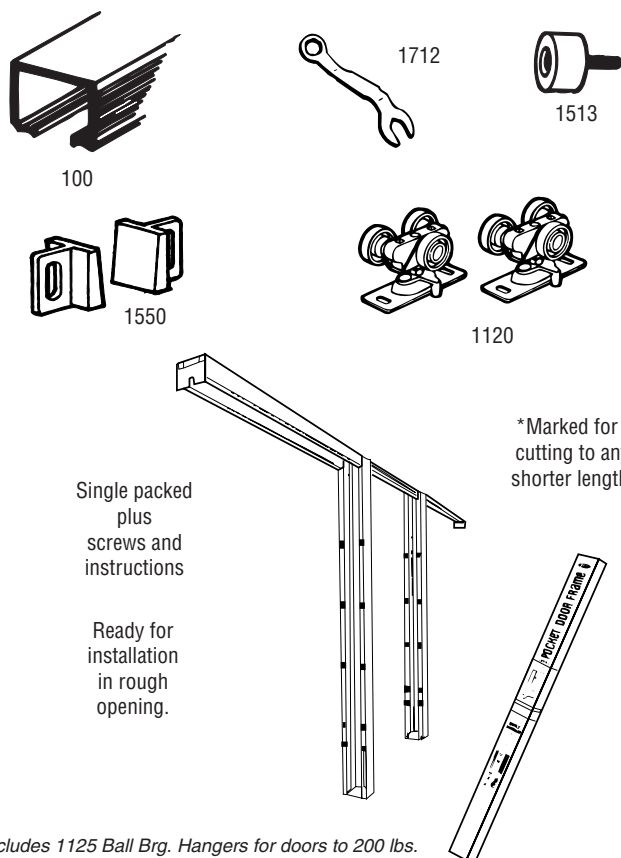

** Includes 1125 Ball Brg. Hangers for doors to 200 lbs.

SPECIAL SIZED FRAME PRICES

All Pocket Door Frames listed below contain #1575 1-3/4" adapter kit and #1125 ball bearing hangers.

Order No.	Door Size
153668PF	42" x 80"
154068PF	48" x 80"
154668PF	54" x 80"
155068PF	60" x 80"

Order No.	Door Size
152070PF	24" x 84"
152470PF	28" x 84"
152670PF	30" x 84"
152870PF	32" x 84"
153070PF	36" x 84"
153670PF	42" x 84"
154070PF	48" x 84"
154670PF	54" x 84"
155070PF	60" x 84"

Order No.	Door Size
152080PF	24" x 96"
152480PF	28" x 96"
152680PF	30" x 96"
152880PF	32" x 96"
153080PF	36" x 96"
153680PF	42" x 96"
154080PF	48" x 96"
154680PF	54" x 96"
155080PF	60" x 96"

Order No.	Door Size
152090PF	24" x 108"
152490PF	28" x 108"
152690PF	30" x 108"
152890PF	32" x 108"
153090PF	36" x 108"
153690PF	42" x 108"
154090PF	48" x 108"
154690PF	54" x 108"
155090PF	60" x 108"

UPRIGHTS

Please Note: 3'6" and 4'0" Frames have 1 extra pair of uprights. 4'6" and 5'0" Frames have 2 extra pairs of uprights.

- #1568UPRT (6'8" W/floor bracket)
- #1570UPRT (7'0" W/floor bracket)
- #1580UPRT (8'0" W/floor bracket)
- #1590UPRT (9'0" W/floor bracket)

HANGERS

- #1120 Standard, maximum weight, 125 lbs.
- #1125 Optional, maximum weight, 200 lbs.
- #1121 Hanger Plate w/screws



ORDERING DATA

Order No.	Door Size	LBS./CASE
15602668	2'6" x 6'8"	31/1
(Marked for cutting to 2/0 and 2/4 door)		
15603068	3'0" x 6'8"	33/1
(Marked for cutting to any size door)		
1555PPK3	Cnvg. Door Kit	3/10

Specify	PKG.
15602668	
15603068	
1555PPK3	

For 2 x 6 construction. Removable aluminum track with convex rails, rust resistant steel reinforced wood split studs, jump proof three wheel (1" dia.) ball bearing hangers, self-adjusting floor anchors, headers marked to cut to smaller door sizes. Brass-tone steelparts.

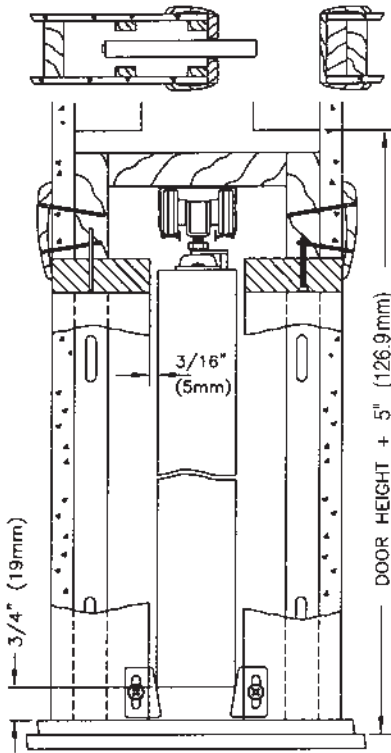

1560

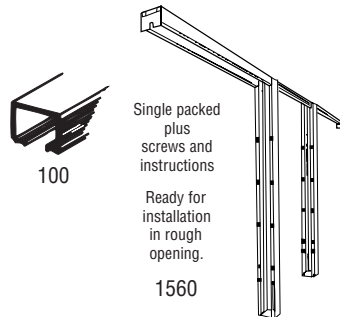

1560 Series Pocket Door Frame Prices

Order No.	Description
15602668	(For doors up to 30" wide x 80" tall)
15603068	(For doors up to 36" wide x 80" tall)
15604068	(For doors up to 48" wide x 80" tall)
15605068	(For doors up to 60" wide x 80" tall)
15602670	(For doors up to 30" wide x 84" tall)
15603070	(For doors up to 36" wide x 84" tall)
15604070	(For doors up to 48" wide x 84" tall)
15605070	(For doors up to 60" wide x 84" tall)
15602680	(For doors up to 30" wide x 96" tall)
15603080	(For doors up to 36" wide x 96" tall)
15604080	(For doors up to 48" wide x 96" tall)
15605080	(For doors up to 60" wide x 96" tall)
15602690	(For doors up to 30" wide x 108" tall)
15603090	(For doors up to 36" wide x 108" tall)
15604090	(For doors up to 48" wide x 108" tall)
15605090	(For doors up to 60" wide x 108" tall)

- ✓ All the features of the 1500 Series.
- ✓ All frames fit 2" x 6" stud walls
- ✓ All 1560 Frames include 1125 Ball Bearing Hangers.
- ✓ 1560 Frames can accommodate doors up to 3" thick.

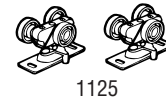

ORDERING DATA

Order No.	Door Size	LBS./CASE
27102068	2'0" x 6'8" Door	23/1
27102468	2'4" x 6'8" Door	26/1
27102668	2'6" x 6'8" Door	27/1
27102868	2'8" x 6'8" Door	28/1
27103068	3'0" x 6'8" Door	31/1
1500PPK3	100 Hrdw. Only	5/10

A "built-up" pocket frame with 10 horizontal members for 2 x 4 construction. Removable aluminum track with convex rails, jump proof three wheel (1" dia.) hangers. Brass-tone steel parts. *Optional hanger #1125 available for doors to 200 lbs.*

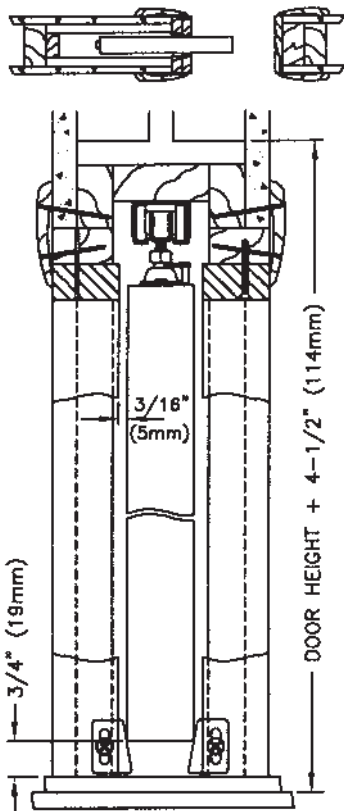

2710

Order No.	PKG.
W/1120	
27102068	
27102468	
27102668	
27102868	
27103068	
1500PPK3	
1555PPK3	

Order No.	PKG.
W/1125*	
27H02068	
27H02468	
27H02668	
27H02868	
27H03068	

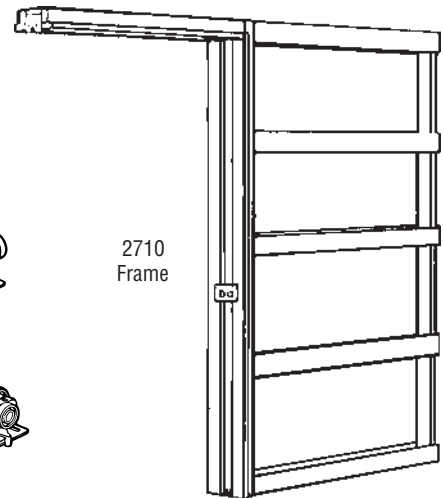
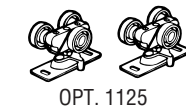
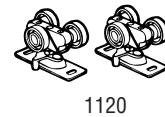
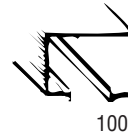

Order No.	PKG.
7'0" Height*	
27102070	
27102470	
27102670	
27102870	
27103070	

Order No.	PKG.
8'0" Height*	
27102080	
27102480	
27102680	
27102880	
27103080	

*All listed above contain 1125 ball bearing hangers for doors up to 200 lbs.



ORDERING DATA

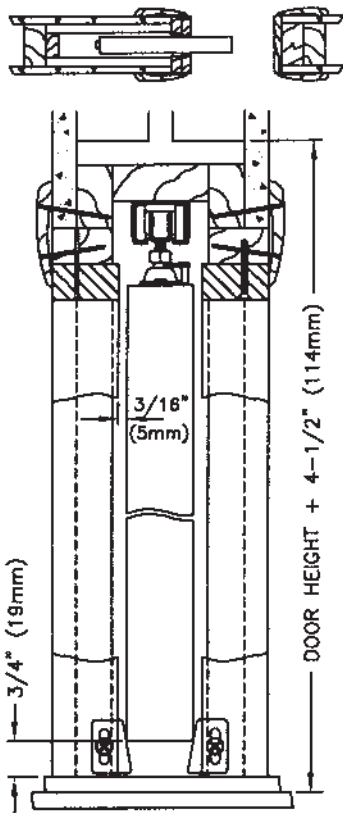

2711

Order No.	Door Size	LBS./CASE
27112068	2' 0" x 6' 8" Door	23/1
27112468	2' 4" x 6' 8" Door	26/1
27112668	2' 6" x 6' 8" Door	27/1
27112868	2' 8" x 6' 8" Door	28/1
27113068	3' 0" x 6' 8" Door	31/1
2511PPK3	111 Hrdw. Only	3/10

Order No.	PKG.
27112068	
27112468	
27112668	
27112868	
27113068	
2511PPK3	
1555PPK3	

***W/1025**

Order No.	PKG.
27H12068	
27H12468	
27H12668	
27H12868	
27H13068	

A "built-up" pocket frame with 10 horizontal members for 2 x 4 construction. Removable aluminum track with convex rails, jump proof three wheel (3/4" dia.) hangers. Brass-tone steel parts.

*Includes #1025 Hanger available for doors up to 150 lbs.

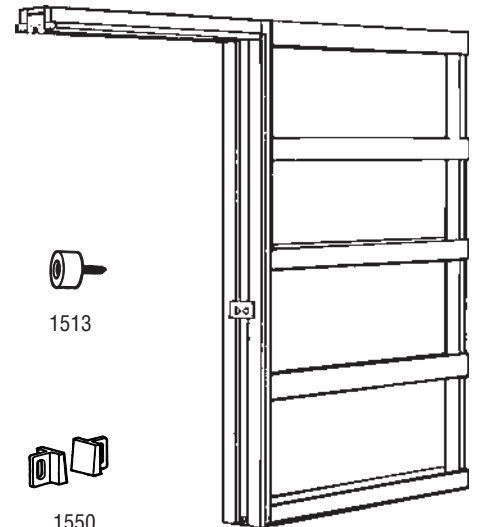
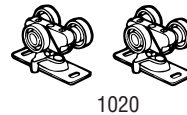

ORDERING DATA

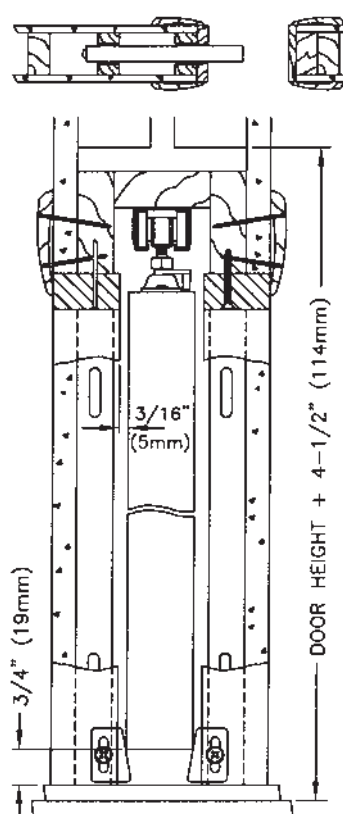

2511

Order No.	Door Size	LBS./CASE
25112668	2' 6" x 6' 8" Door	27/1
<i>(Marked for cutting 2/0 and 2/4 door)</i>		
25113068	3' 0" x 6' 8" Door	29/1
<i>(Marked for cutting to any size door)</i>		
2511PPK3	Hardware Set	4/10
1555PPK3	Converging Door Kit	3/10
1575PPK3	Adaptor Kit 1-3/4" Door	5/10

Order No.	PKG.	HDW/1025*
25112668		
25113068		
2511PPK3		
1555PPK3		
1575PPK3		

For 2 x 4 construction. Removable aluminum track with convex rails, rust resistant steel reinforced wood split studs, jump proof three wheel (3/4" dia.) hangers, self-adjusting floor anchors, headers marked to cut to smaller door sizes. Brass-tone steel parts.

*Includes #1025 Hanger available for doors up to 150 lbs.

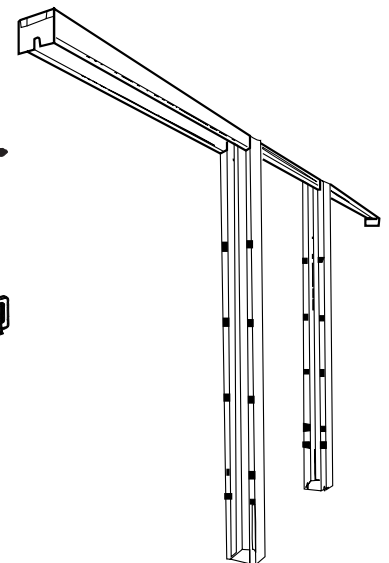
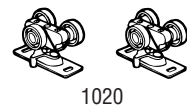



ORDERING DATA

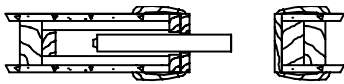

Order No.	Door Size	LBS./CASE
200481DR	(One 2'0" Door)	
200601DR	(One 2'6" Door)	
200721DR	(One 3'0" Door)	7/1
200961DR	(One 4'0" Door)	9/1

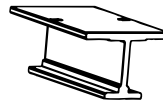

200



1550



1513

Order No.	PKG.	BULK
200481DR		
200601DR		
200721DR		
200961DR		

Bulk
5/CT.

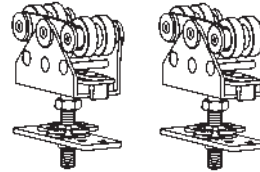

2020 Hanger
2021 Door Plate

A deluxe commercial grade hardware. Can be used for pocket doors or in combination with itself to make special installations of sliding doors. Heavy duty I-beam aluminum track. Four wheel (1" dia.) ball bearing hangers. Brass-tone steel parts.

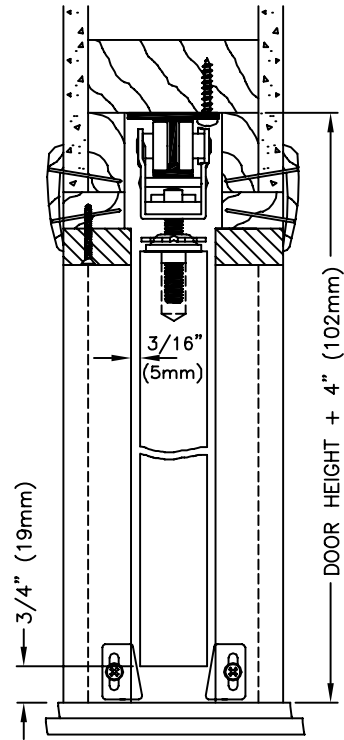

200PD



ORDERING DATA



Order No.	Door Size	LBS./CASE
100481DR	(One 2'0" Door)	12/5
100601DR	(One 2'6" Door)	14/5
100721DR	(One 3'0" Door)	16/5
100961DR	(One 4'0" Door)	20/5



100



1550



1513

Order No.	PKG.	BULK
100481DR		
100601DR		
100721DR		
100961DR		

Bulk
25/CT.



1120

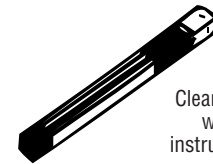

Clear wrap
with
instructions

Can be used for pocket door frames or in combination with itself to make special installations of sliding doors. Aluminum track with convex rails, jump proof three wheel (1" dia.) hangers assure a smooth quiet operation. Brass-tone steel parts. *Optional hanger #1125 available for doors to 200 lbs.*

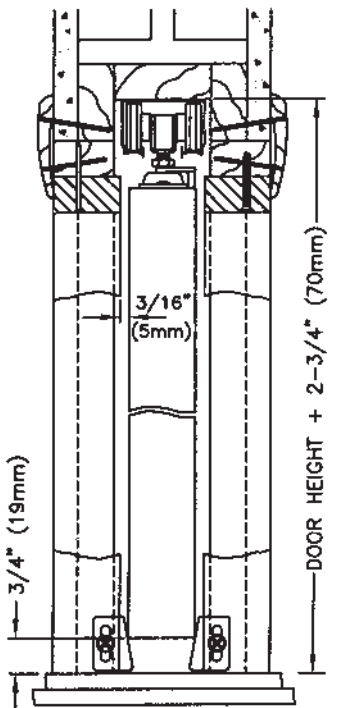

100PD



ORDERING DATA

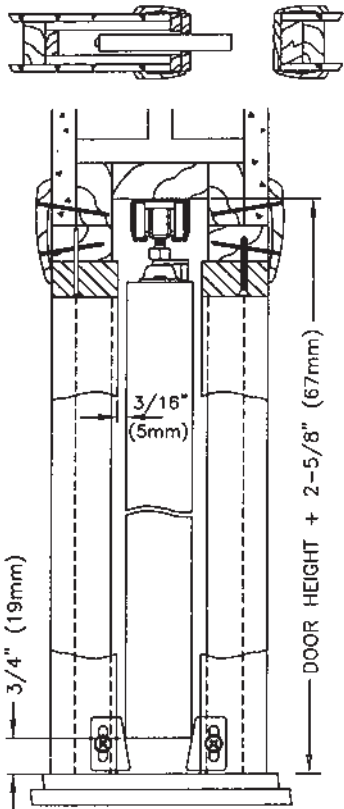

111PD

Order No.	Door Size	LBS./CASE
111481DR	(One 2'0" Door)	8/5
111601DR	(One 2'6" Door)	9/5
111721DR	(One 3'0" Door)	10/5
111961DR	(One 4'0" Door)	12/5

Order No.	PKG.	BULK
111481DR		
111601DR		
111721DR		
111961DR		

Bulk
25/CT.

Can be used for pocket door frames or in combination with itself to make special installations of sliding doors. Aluminum track with convex rails, jump proof three wheel (3/4" dia.) hangers assure a smooth quiet operation. Brass-tone steel parts. *Optional hanger #1025 available for doors to 150 lbs.*

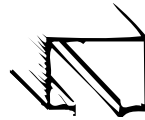

111 Track



1550



1513

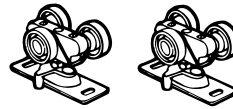

1020



1712

2800F Double Fascia Open Pocket Hardware for a single 1-3/8" or 1-3/4" door to 75 lbs.

ORDERING DATA

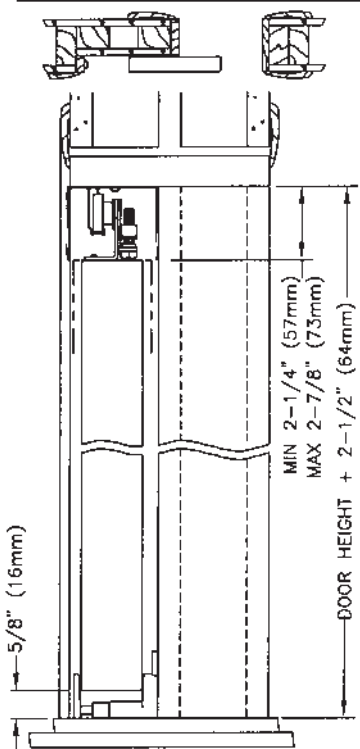

2800F

Order No.	Door Size	LBS./CASE
2800F481	(One 2'0" Door)	
2800F601	(One 2'6" Door)	
2800F721	(One 3'0" Door)	20/5
2800F961	(One 4'0" Door)	25/5

Order No.	PKG.	BULK
2800F481		
2800F601		
2800F721		
2800F961		

Bulk
20/CT.

Space saving, header mounted "Open Pocket Door" hardware set. Aluminum double fascia track with a single convex rail, twin wheel (7/8" dia.) ball bearing hangers, wall mount guide. Brass-tone steel parts.

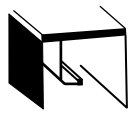

2800F



2815



1513



12

2800 Pocket Door Hardware for a single 1-1/8" door or larger to 50 lbs.

ORDERING DATA

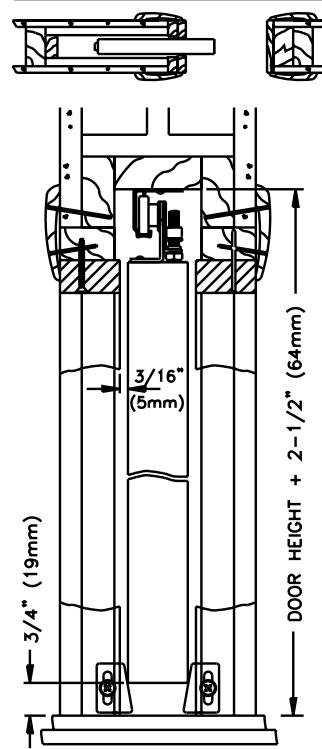

2800

Order No.	Door Size	LBS./CASE
2800481D	(One 2'0" Door)	
2800601D	(One 2'6" Door)	
2800721D	(One 3'0" Door)	9/5
2800961D	(One 4'0" Door)	11/5

Order No.	PKG.	BULK
2800481D		
2800601D		
2800721D		
2800961D		

Bulk
25/CT.

An economical aluminum track with a single convex rail, which provides one point contact between wheel and track. One wheel (7/8" dia.) hanger. Brass-tone steel parts.

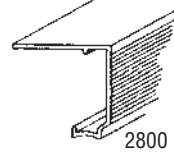

2800

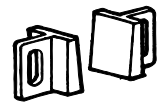

1550



2802



1513



Clear wrap with instructions

2850 Pocket Door Hardware for a single
1-1/8" door or larger to 50 lbs.

14

1510/11 Universal Pocket Door Frame
Jamb Kit. (for 4-9/16" walls)

ORDERING DATA

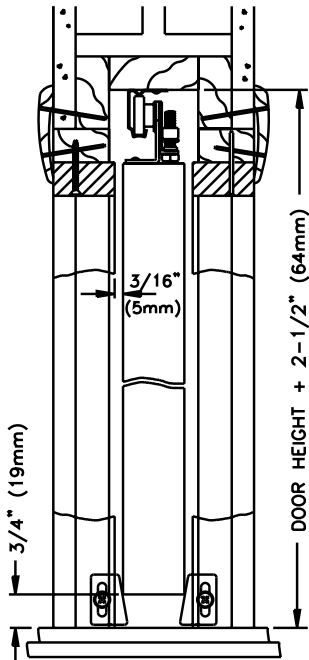
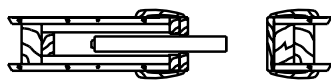

2850

Order No.	Door Size	LBS./CASE
2850481D	(One 2'0" Door)	
2850601D	(One 2'6" Door)	
2850721D	(One 3'0" Door)	11/5
2850961D	(One 4'0" Door)	14/5
Order No.	PKG.	BULK
2850481D		
2850601D		
2850721D		
2850961D		

Bulk
25/CT.

An economical painted steel track with a single convex rail, which provides one point contact between wheel and track. One wheel (7/8" dia.) hanger. Brass-tone steel parts.

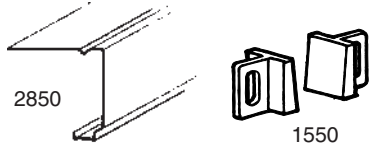

2850

1550



2802

1513



Clear wrap with instructions

ORDERING DATA

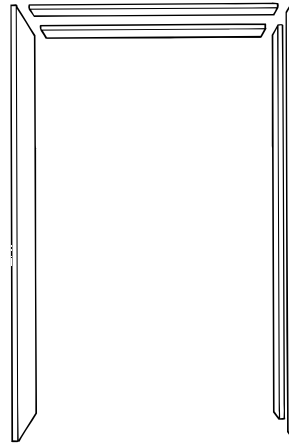

1510/11

Order No.	Door Size	LBS./CASE
<i>Primed Finger Joint Clear Pine</i>		
15103068	3'0" x 6'8"	20/3
<i>Clear Pine Veneer</i>		
15113068	3'0" x 6'8"	22/3

Order No.	PKG.
15103068	
15113068	

A fast convenient method of finishing a Pocket Door Frame. Just cut to length and install-no ripping of special thickness stock. Presanded so finishing is a snap. (Since a wide variety of casings are available, they are not included.) Cannot be used with 2000 Series Frame.

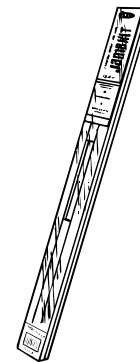

1521 (for 1-3/8" doors only)
1534 (for 1-3/4" doors only)

Pocket Door Privacy Locks and Passage Latches.

ORDERING DATA

Order No.	LBS./CASE	
1521 Suncrest PRIVACY	2.5/5	
Order No.	PKG.	BULK
1521 Suncrest		
21-PPK Dummy Pull		

Bulk
25/CT.

Privacy locks fit in standard 2-3/8" back set, 2-1/8" bore with a 15/16" end bore for latch bolt. Lock features automatic latching when closed, simple touch-of-a-button locking with emergency release and non-handed. Ideal for converging doors. Available in three finishes US3-Bright Brass, US5-Antique Brass, and US26D-Satin Chrome.

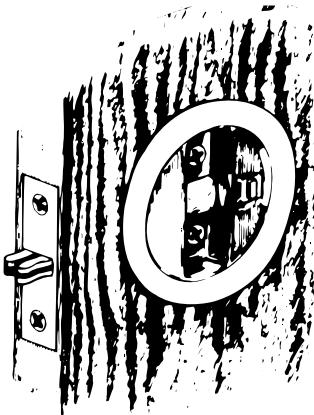

1521 "Suncrest" Lock



150 Edge Pull
Finished in US3 (Bright Brass) and US26 (Satin Chrome).
See pages 25, 26.



21-PPK "Suncrest" Dummy Pull

ORDERING DATA

Order No.	LBS./CASE	
1534 Suncrest PRIVACY	.6/1	
Order No.	PKG.	BULK
1534 Suncrest		
134 Dummy Pull		

Bulk
5/CT.

Privacy locks fit in standard 2-3/8" back set, 2-1/8" bore with a 15/16" dia. end bore for latch bolt. Lock features automatic latching when closed, simple touch-of-a-button locking with emergency release and non-handed. Ideal for converging doors. Available in three decorator finishes; US3-Bright Brass, US5-Antique Brass, and US26D-Satin Chrome.



1534 "Suncrest" Lock



134 "Suncrest" Dummy Pull

ORDERING DATA

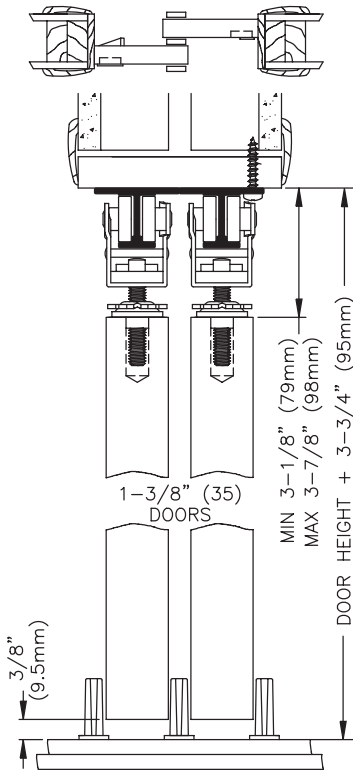

200SD

Order No.	Opening	LBS./CASE
200482DR	48"-2 Door	
200602DR	60"-2 Door	
200722DR	72"-2 Door	14/1
200962DR	96"-2 Door	17/1
2001443D	144"-3 Door	

Order No.	PKG.	BULK
200482DR		
200602DR		
200722DR		
200962DR		
2001443D		

Bulk
5/CT.

A deluxe commercial grade hardware. Heavy duty extruded aluminum I-beam track. Four wheel ball bearing hangers with machine turned 1" wheels. Heavy duty guide with steel reinforced nylon posts. Brass-tone steel parts. *(Minimum door thickness is 1-1/8".)*

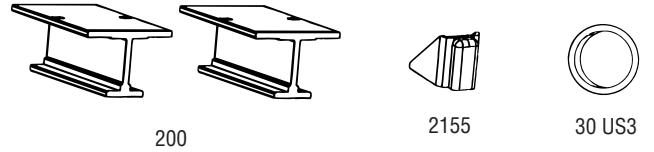

2031
Heavy Duty
Single Guide
(3 included)

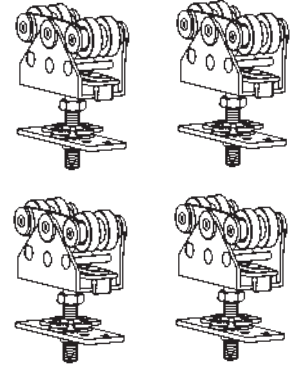

2020 Hanger
2021 Door Plate

ORDERING DATA

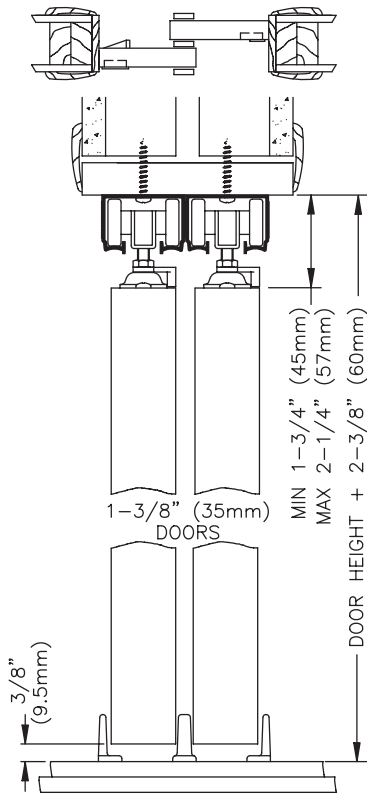

100SD

Order No.	Opening	LBS./CASE
100482DR	48"-2 Door	
100602DR	60"-2 Door	
100722DR	72"-2 Door	
100962DR	96"-2 Door	
1001443D	144"-3 Door	

Order No.	PKG.	BULK
100482DR		
100602DR		
100722DR		
100962DR		
1001443D		

Bulk
10/CT.

A commercial-grade bypass sliding door hardware set for doors weighing up to 200 pounds each. Heavy-duty extruded aluminum box track utilizes three-wheeled ball-bearing rollers (part #1125) with 1" diameter machine turned wheels. The three piece guide is adjustable for different thicknesses of doors. *(Minimum door thickness is 1".)*

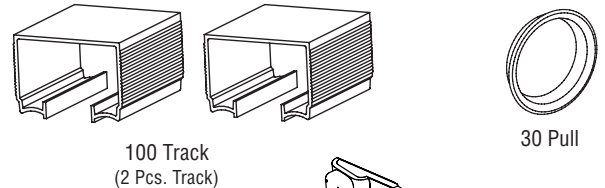

2155

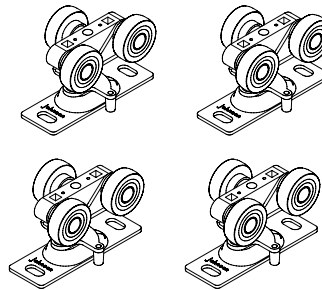

1125 Hanger
(1" Dia.)

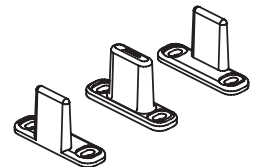

101
Guide

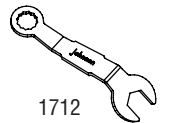

1712
Wrench

ORDERING DATA

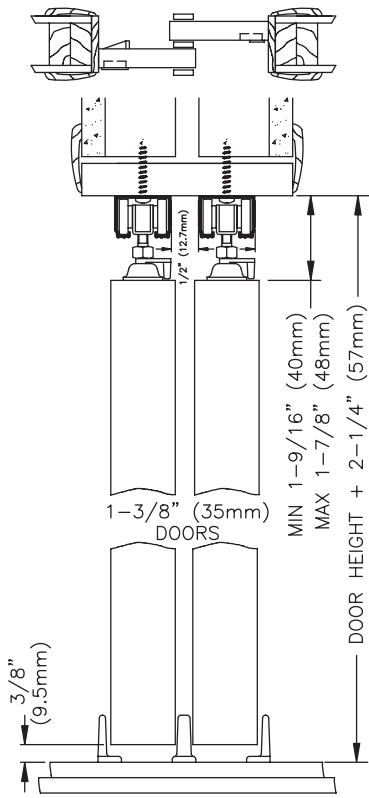

111SD

Order No.	Opening	LBS./CASE
111482DR	48"-2 Door	
111602DR	60"-2 Door	
111722DR	72"-2 Door	
111962DR	96"-2 Door	
1111443D	144"-3 Door	

Order No.	PKG.	BULK
111482DR		
111602DR		
111722DR		
111962DR		
1111443D		

Bulk
10/CT.

A commercial-grade bypass sliding door hardware set for doors weighing up to 150 pounds each. Heavy-duty extruded aluminum box track utilizes three-wheeled ball-bearing rollers (part #1025) with 3/4" diameter machine turned wheels. The three piece guide is adjustable for different thicknesses of doors. (Minimum door thickness is 3/4".)

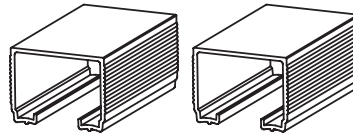

111 Track
(2 Pcs. Track)

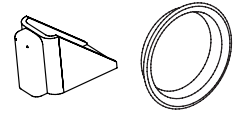

2155

30 Pull

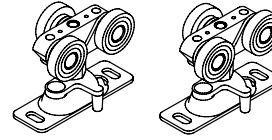

1025 Hanger
(3/4" Dia.)

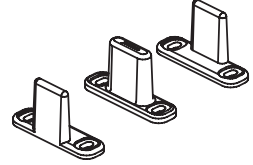

101
Guide

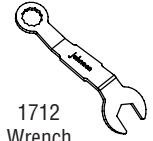
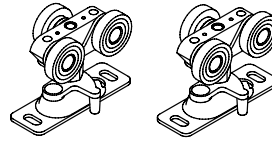

1712
Wrench

ORDERING DATA

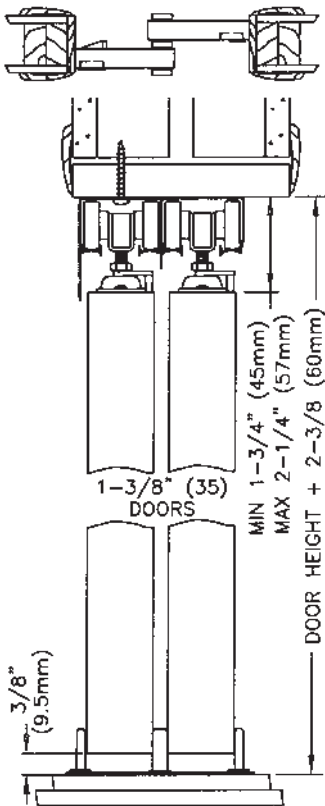

138F

Order No.	Opening	LBS./CASE
138F482D	48"-2 Door	22/5
138F602D	60"-2 Door	26/5
138F722D	72"-2 Door	30/5
138F964D	96"-4 Door	26/3

Order No.	PKG.	BULK
138F482D		
138F602D		
138F722D		
138F964D		

Bulk
10/CT.

Commercial grade aluminum fascia track with line design to hide fingerprints and scratches. Three wheel (1" dia.) hangers ride on convex rails for a smooth quiet operation. Four way adjustable floor guide. Brass-tone steel parts. *Optional hanger #1125 available for doors to 200 lbs.*

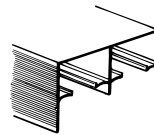

138F

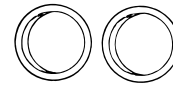

30 US3

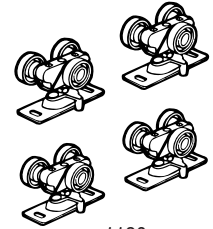

1120

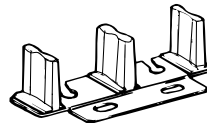

2135



2155

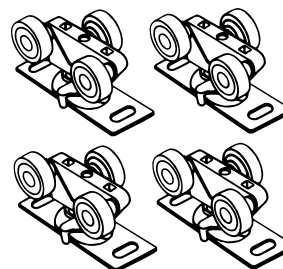

Optional Hanger 1125



1155 Stops inc.
w/4 dr. sets

ORDERING DATA

Order No.	Opening	LBS./CASE
134F482D	48"-2 Door	24/5
134F602D	60"-2 Door	29/5
134F722D	72"-2 Door	33/5
134F964D	96"-4 Door	30/3

Order No.	PKG.	BULK
134F482D		
134F602D		
134F722D		
134F964D		

Bulk
10/CT.

Commercial grade track with an aluminum fascia which hides hangers from view. Three wheel (1" dia.) hangers ride on convex rails for a smooth quiet operation. Door guide is woodtone with pivot action that align guide post with door. Brass-tone steel parts. *Optional hanger #1125 available for doors to 200lbs.*

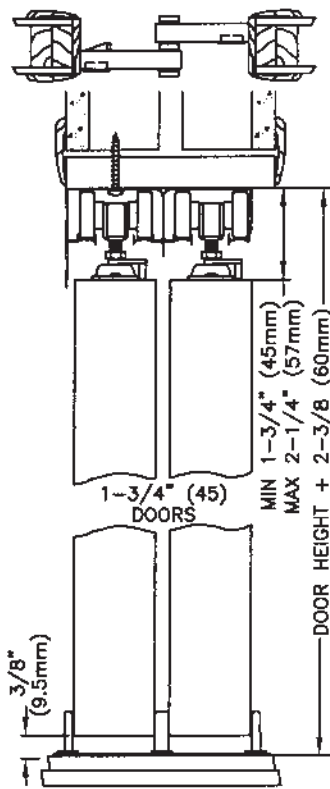

134F

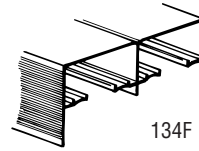

134F

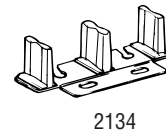

2134

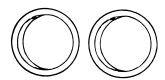

30 US3



1155 Stops incl. w/4 dr. sets

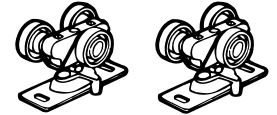

1120



2155

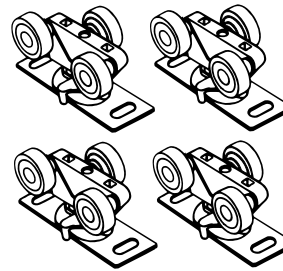

Optional Hanger 1125

ORDERING DATA

Order No.	Opening	LBS./CASE
118F482D	48"-2 Door	17/5
118F602D	60"-2 Door	21/5
118F722D	72"-2 Door	24/5
118F964D	96"-4 Door	34/5

Order No.	PKG.	BULK
118F482D		
118F602D		
118F722D		
118F964D		

Bulk
20/CT.

Commercial grade aluminum fascia track with line design to hide scratches and hold paint. Three wheel (3/4" dia.) hangers ride on convex rails for a smooth quiet operation. Mount or dismount doors with a flip of the clip. One inch high woodtone adjustable door guide. Brass-tone steel parts.

*Optional Hanger 1025 available for doors to 150 lbs.

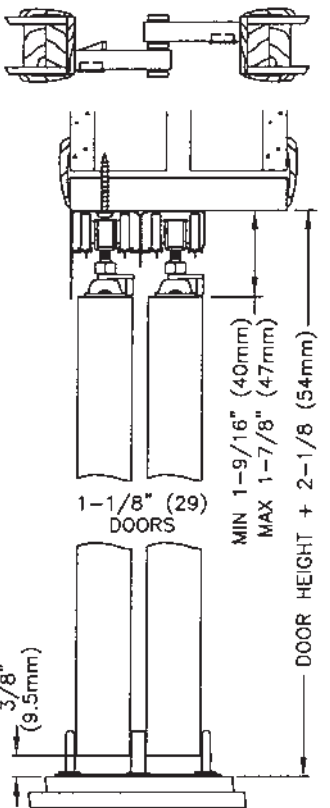

118F

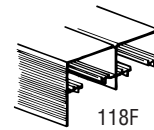

118F



30 US3

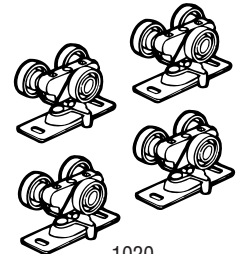

1020



2155



2118

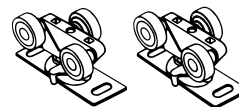

Optional Hanger 1025



1155 Stops inc. w/4 dr. sets

2200F Bypass Fascia Track for 1-3/8" doors to 50 lbs.
(One Wheel) or 75 lbs. (Two Wheel)

ORDERING DATA

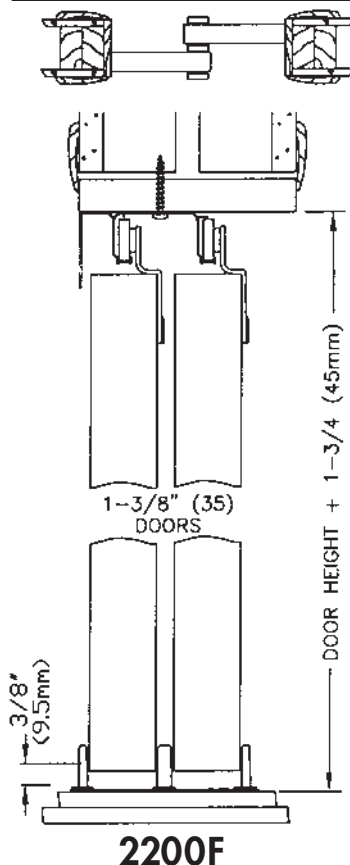

Order No.	Opening	LBS./CASE
2200F481	48" 2 Door	13/5
2200F601	60" 2 Door	15/5
2200F721	72" 2 Door	16/5
2200F961	96" 4 Door	26/5
*2200F482	48" 2 Door	14/5
*2200F602	60" 2 Door	16/5
*2200F722	72" 2 Door	18/5
*2200F962	96" 4 Door	27/5

Order No.	PKG.	BULK
2200F481		
2200F601		
2200F721		
2200F961		
*2200F482		
*2200F602		
*2200F722		
*2200F962		

Bulk
25/CT.

An aluminum fascia track with "Hi-Lite" design to hide blemishes that may occur. Convex track rails that provide one point contact between wheel and track. Hangers include one or two wheel (7/8" DIA.) with three point locking. Hangers adjust without removing or relocating screws. Woodtone guide adjusts laterally for quick plumbing. Nylon guide posts are 1" high, guide posts swivel to allow warped doors to operate without binding. Brass-tone steel parts.

* 2 Wheel Hangers

Two door contents shown



2200F



2238

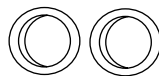

15



2255 stop kit
incl. with 4 dr. sets

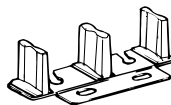

2135



*2228
Optional



Clear wrap
with instructions

2222 Bypass Track with Wood Header for 1-3/8" doors to 50 lbs. (One Wheel) or 75 lbs. (Two Wheel)

ORDERING DATA

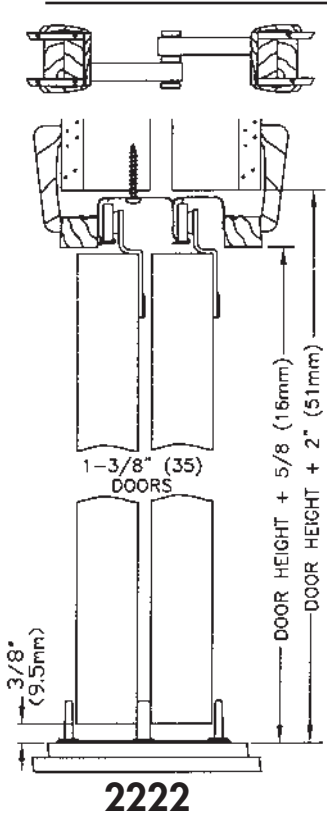

Order No.	Opening	LBS./CASE
22224814	48" 2 Door	---
22226014	60" 2 Door	---
22227214	72" 2 Door	---
22229614	96" 4 Door	Bulk
*22224824	48" 2 Door	Only
*22226024	60" 2 Door	10/CT.
*22227224	72" 2 Door	---
*22229624	96" 4 Door	---

Order No.	PKG.	BULK
22224814		
22226014		
22227214		
22229614		
*22224824	Track	
*22226024	Track	
*22227224	Only	
*22229624	Pg. 23	

Prefabricated header with aluminum track replaces the regular head jamb. Keeps the bypass doors the same trim height as swinging doors. Eliminates odd door heights. Convex track rails, 7/8" dia. wheels, adjustable hangers, adjustable guide. Brass-tone steel parts. Also available for 5-1/4" jambs and without wood. Contact factory

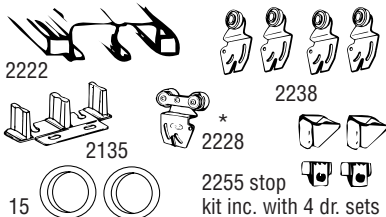

2204F Bypass Fascia Track for 3/4" doors to 50 lbs.

ORDERING DATA

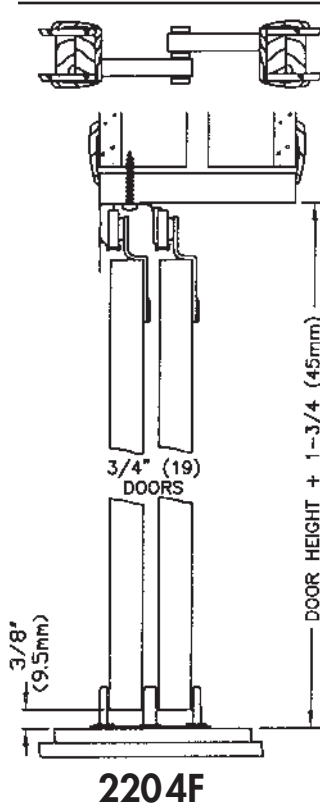

Order No.	Opening	LBS./CASE
2204F481	48" 2 Door	---
2204F601	60" 2 Door	---
2204F721	72" 2 Door	15/5
2204F961	96" 4 Door	22/5

Order No.	PKG.	BULK
2204F481		
2204F601		
2204F721		
2204F961		

Bulk
20/CT.

An aluminum fascia bypass track to be used with 3/4" plywood or particle board doors. Same features as the 2200F Series.

Two door contents shown



2204F



2238

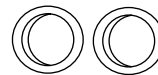

15



2175

2255 stop kit incl.
with 4 dr. sets

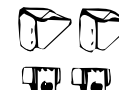

ORDERING DATA

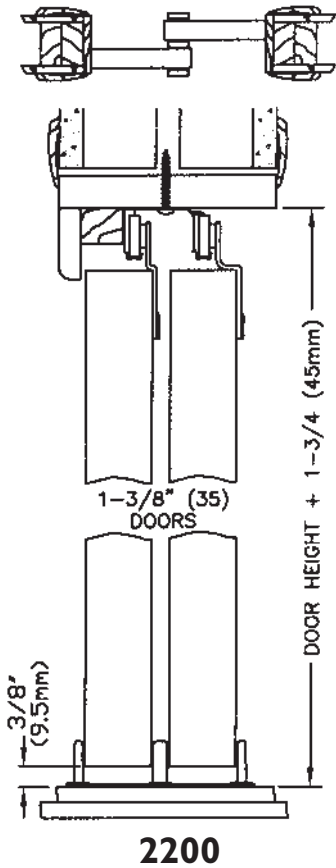

2200

Order No.	Opening	LBS./CASE
2200482D	48" 2 Door	10/5
2200602D	60" 2 Door	12/5
2200722D	72" 2 Door	13/5
2200964D	96" 4 Door	19/5

Order No.	PKG.	BULK
2200482D		
2200602D		
2200722D		
2200964D		

Bulk
25/CT.

Aluminum bypass track with convex track rails for quiet smooth operation. One wheel (7/8" dia.) hangers with three point locking provide one point contact between wheel and track. One inch high woodtone adjustable door guide. Brass-tone steel parts.

Two door contents shown

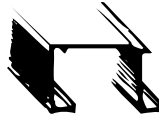

2200

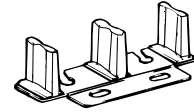

2135

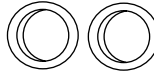

15

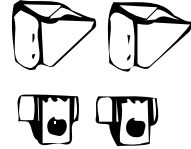

2255 stop kit
incl. with 4 dr. sets



2216

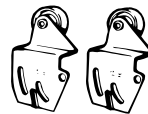

2238

Clear wrap
with instructions

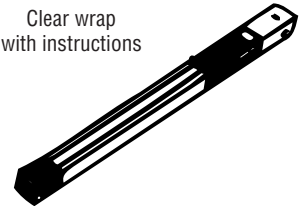

ORDERING DATA

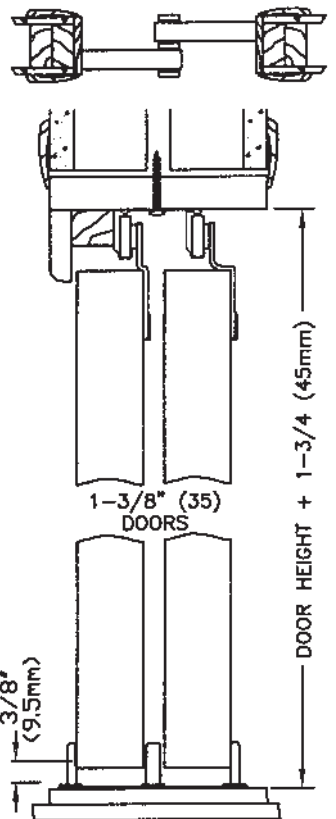

1166

Order No.	Opening	LBS./Case
1166G482	48" 2 Door	13/5
1166G602	60" 2 Door	16/5
1166G722	72" 2 Door	18/5
1166G964	96" 4 Door	26/5

Order No.	PKG.	BULK
1166G482		
1166G602		
1166G722		
1166G964		

Bulk
25/CT.

An economical prefinished gold colored steel bypass track with convex track rails, which provide one point contact between wheel and track. One wheel (7/8" dia.) hangers with three point locking. One inch high woodtone adjustable door guide. Brass-tone steel parts.

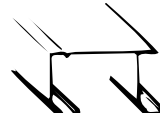

1166

Two door contents shown

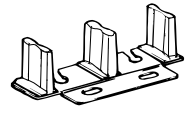

2135

2255 stop kit
incl. with
4 dr. sets

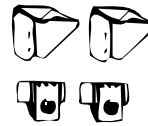

2216

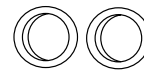

15



2238

Clear wrap
with instructions

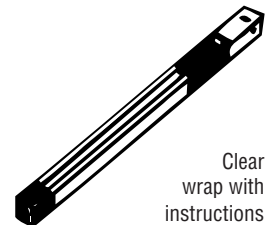

ORDERING DATA

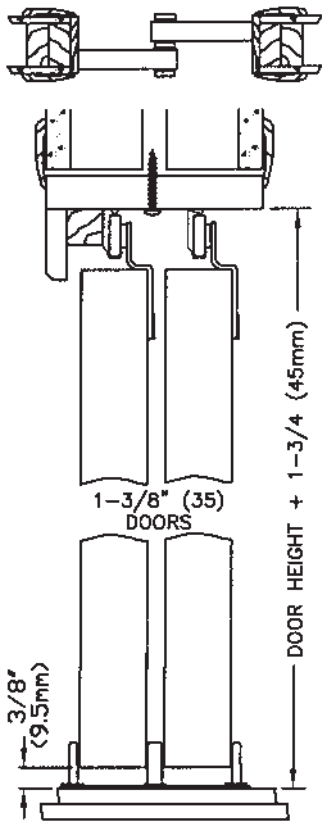

1138

Order No.	Opening	LBS./CASE
1138482D	48" 2 Door	13/5
1138602D	60" 2 Door	16/5
1138722D	72" 2 Door	19/5
1138964D	96" 4 Door	27/5

Order No.	PKG.	BULK
1138482D		
1138602D		
1138722D		
1138964D		
		Bulk 20/CT.

An economical prefinished gold colored steel bypass track with convex track rails, which provide one point contact between wheel and track. One wheel (7/8" dia.) hangers with three point locking. One inch high woodtone adjustable door guide. Brass-tone steel parts.

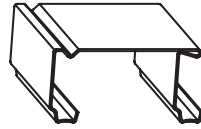

1138

Two door contents shown

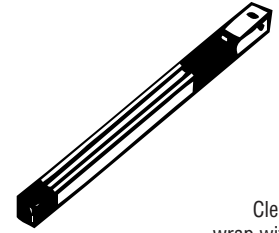

Clear wrap with instructions

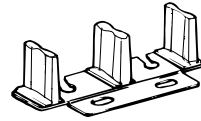

2135



2255 stop kit included with 4 door sets



2238

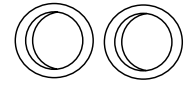

15

113F Bypass Track with Fascia for 1-3/8" doors to 50 lbs.

ORDERING DATA

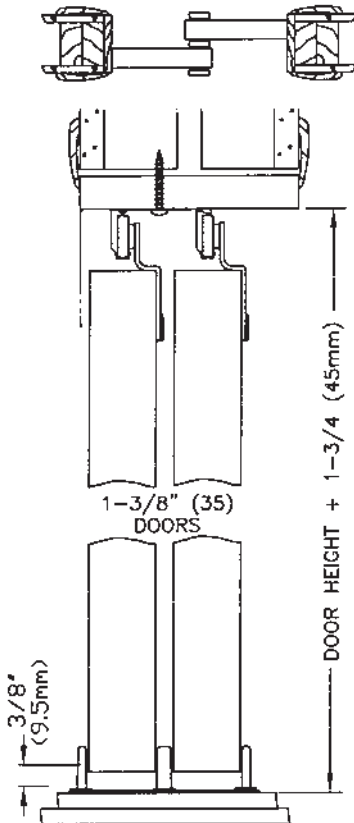

113F

Order No.	Opening	LBS./CASE
113FG481	48" 2 Door	19/5
113FG601	60" 2 Door	23/5
113FG721	72" 2 Door	27/5
113FG961	96" 4 Door	38/5

Order No.	PKG.	BULK
113FG481		
113FG601		
113FG721		
113FG961		
		Bulk 20/CT.

An economical prefinished gold colored steel bypass track with a "Snap-on Fascia". Convex track rails, which provide one point contact between wheel and track. One wheel (7/8" dia.) hangers with three point locking. Woodtone adjustable door guide. Brass-tone steel parts.



1138
Two door contents shown



126F

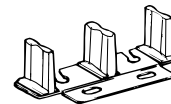

2135



2255 stop kit included with 4 door sets

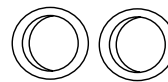

15

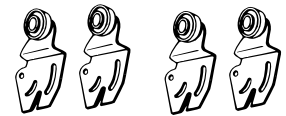

2238

Multiple-Door Sliding Sets

Typical 3 track layouts for 1-3/8" or 1-3/4" doors.

Shown below are typical 3 track layouts for 1-3/8" or 1-3/4" doors. Other door thicknesses may be used in some situations. Also, more than 3 tracks may be used by extending header and using other track combinations as required. Refer to individual catalog pages for weight carrying capacity and hanger types available. No broken carton charges or cutting fees on MD sets.

200MD Series – 300 LB. Doors

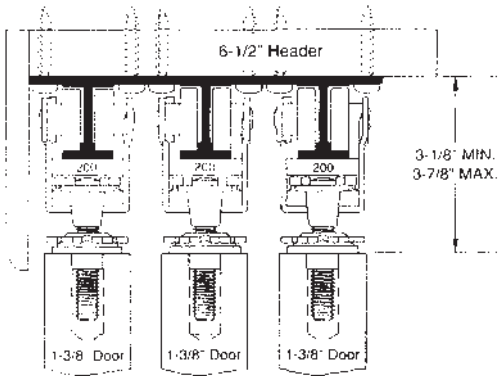

200MD Series – Pre-Packaged Hardware Sets – 300 LB. Doors (min. 1-1/8" thick)

DESCRIPTION	PART NO.	TRACK LENGTH	MAX. DOOR WIDTH (ea.)	MAX. DOOR WEIGHT (ea.)
2055 Track Stop 200 2020 1050 Track 1705 Guide	200M0723	70" (1829mm)	24" x 3 (610mm x 3)	300 lbs. (136 kg.)
	200M0963	94" (2438mm)	32" x 3 (813mm x 3)	300 lbs. (136 kg.)
	200M1083	106" (2692mm)	36" x 3 (914mm x 3)	300 lbs. (136 kg.)
	200M1443	142" (3657mm)	48" x 3 (1219mm x 3)	300 lbs. (136 kg.)

3-Door Set Contents:
 3 - 200 Track Lengths
 3 - 1050 Bottom Guide Lengths
 6 - 2020 Ball Bearing Hangers
 6 - 1705 Bottom Door Guides
 2 - 2055 Track Stops

100MD Series – 200 LB. Doors

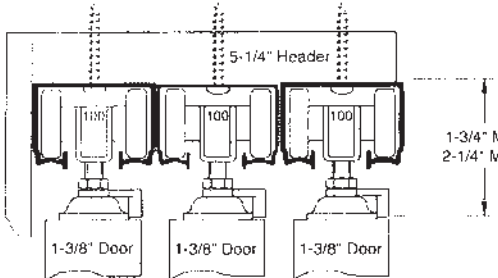

100MD Series – Pre-Packaged Hardware Sets – 200 LB. Doors (min. 1" thick)

DESCRIPTION	PART NO.	TRACK LENGTH	MAX. DOOR WIDTH (ea.)	MAX. DOOR WEIGHT (ea.)
100 1125 1155 Stop 1050 Track 1705 Guide	100M0723	70" (1829mm)	24" x 3 (610mm x 3)	200 lbs. (91 kg.)
	100M0963	94" (2438mm)	32" x 3 (813mm x 3)	200 lbs. (91 kg.)
	100M1083	106" (2692mm)	36" x 3 (914mm x 3)	200 lbs. (91 kg.)
	100M1443	142" (3657mm)	48" x 3 (1219mm x 3)	200 lbs. (91 kg.)

3-Door Set Contents:
 3 - 100 Track Lengths
 3 - 1050 Bottom Guide Lengths
 6 - 1125 Ball Bearing Hangers
 6 - 1705 Bottom Door Guides
 2 - 1155 Track Mount Stops
 1 - 1712 Adjustment Wrench

111MD Series – 150 LB. Doors

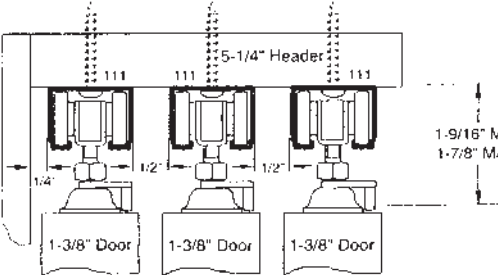

111MD Series – Pre-Packaged Hardware Sets – 150 LB. Doors (min. 3/4" thick)

DESCRIPTION	PART NO.	TRACK LENGTH	MAX. DOOR WIDTH (ea.)	MAX. DOOR WEIGHT (ea.)
111 1025 1155 Stop 1050 Track 1705 Guide	111M0723	70" (1829mm)	24" x 3 (610mm x 3)	150 lbs. (68 kg.)
	111M0963	94" (2438mm)	32" x 3 (813mm x 3)	150 lbs. (68 kg.)
	111M1083	106" (2692mm)	36" x 3 (914mm x 3)	150 lbs. (68 kg.)
	111M1443	142" (3657mm)	48" x 3 (1219mm x 3)	150 lbs. (68 kg.)

3-Door Set Contents:
 3 - 111 Track Lengths
 3 - 1050 Bottom Guide Lengths
 6 - 1025 Ball Bearing Hangers
 6 - 1705 Bottom Door Guides
 2 - 1155 Track Mount Stops
 1 - 1712 Adjustment Wrench

Bottom Track – Included w/all Sets

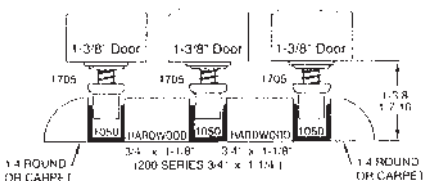

2054 PLBG
MULTI PULL CATCH

2054 PLBG Multi Pull Catch

All nosing and hardware filler supplied by others. Surface mount shown may be recessed into floor. Spacing and dimensions will vary with other door thicknesses.

Tracks can be cut down for smaller openings.

DOOR PANEL DISPLAY

USING JOHNSON 100 SERIES TRACK AND HARDWARE

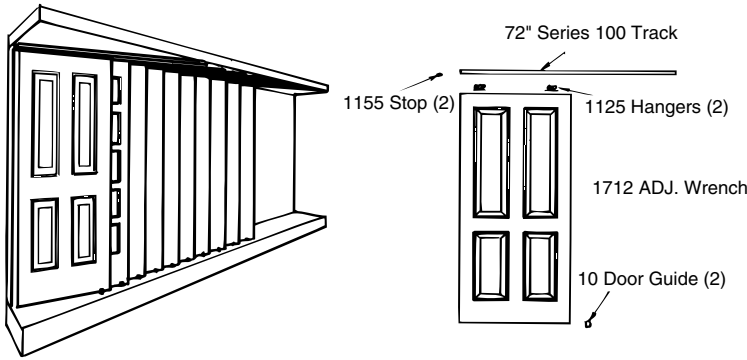

Packed 25 per carton
PER ONE DOOR SET

NO MORE WRESTLING WITH LOOSE PANELS OR DOORS!

Display your doors with easy-to-construct sliding "show walls". These displays take up less floor space than the old methods of stacking or leaning doors.

The **Door Panel Display** uses the same track and hanger system as in the Johnson 1500 Pocket Door Frame and can handle 3'0" doors up to **200 lbs.**

TABLE LEGS

8800 Folding Table Leg

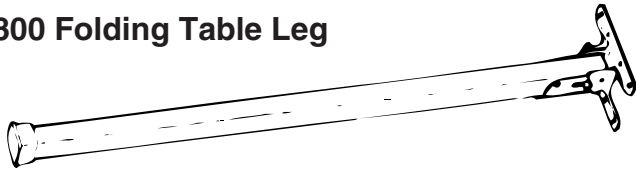

STOCK LENGTHS

Part No.	Length	Pkg/Qty.	Weight
88265-WT	26-1/2"	20/Ctn	28 lbs
88275-WT	27-1/2"	20/Ctn	28 lbs
88285-WT	28-1/2"	20/Ctn	29 lbs
88295-WT	29-1/2"	20/Ctn	29 lbs
88305-WT	30-1/2"	20/Ctn	30 lbs

88ADJ-WT Adjustable Table Leg

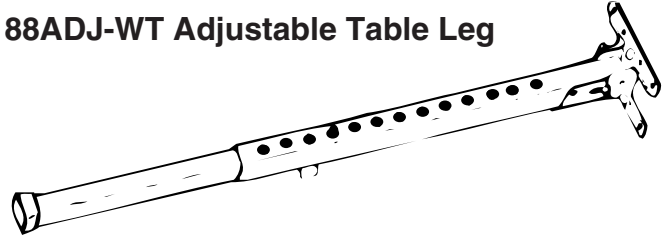

13 Lengths from 19-1/2" to 31-1/2"
at 1" intervals.

20/Ctn

29 lbs.

88TEL-WT Telescoping Table Leg

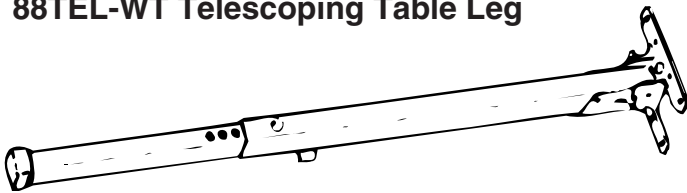

Lengths when open from 26" to 31-1/2"
preset at 1/2" intervals.
Closes to 19".

20/Ctn

7800 Folding Gaucho Leg

(Non-stock item)

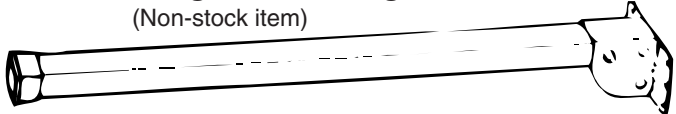

STOCK LENGTHS

Part No.	Length	Pkg/Qty.	Weight
78245-WT	24-1/2"	20/Ctn	23 lbs
78255-WT	25-1/2"	20/Ctn	24 lbs
78265-WT	26-1/2"	20/Ctn	25 lbs
78275-WT	27-1/2"	20/Ctn	26 lbs
78285-WT	28-1/2"	20/Ctn	26 lbs
78295-WT	29-1/2"	20/Ctn	27 lbs
78305-WT	30-1/2"	20/Ctn	28 lbs

7700 Fixed Length Gaucho Leg

(Non-stock item)

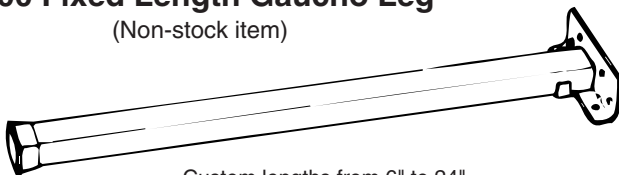

Custom lengths from 6" to 24"
at 1/2" intervals.

6" to 12" — 40/Ctn
12-1/2" to 18" — 20/Ctn
18-1/2" to 24" — 20/Ctn

955022PS Pantry Slide

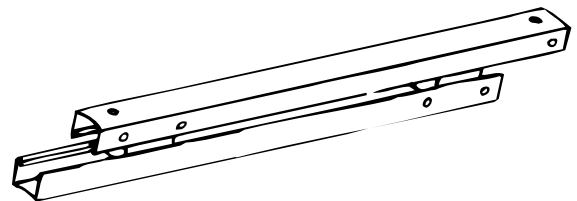

Standard length 22", opens to 38".
Can be special ordered to other lengths.

10/Ctn

100  25/cs
Aluminum

36" 48" 60" 72" 96" 106" 120" 144" 192"

111  25/cs
Aluminum

36" 48" 60" 72" 96" 106" 120" 144" 192"

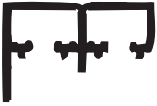
118F  20/cs
Aluminum 1/4X

48" 60" 72" 96" 106" 120" 144" 192"

134F  10/cs
Aluminum 1/4X

48" 60" 72" 96" 106" 120" 144" 192"

138F  10/cs
Aluminum 1/4X

48" 60" 72" 96" 106" 120" 144" 192"

170A  20/cs
Aluminum

24" 30" 32" 36" 48" 60"
72" 96" 106" 120" 144" 192"

200  5/CS
Aluminum W: 1 7/8" H: 1 5/16"

48" 60" 72" 96" 106" 120" 144" 192"

1050  6/cs
Aluminum W: 5/8" H: 5/8" (Actual Size)

72" 96" 106" 144"

1138  20/cs
Steel

47" 59" 71" 94" 106" 120" 144" 192"

1166  25/cs
Steel

47" 59" 71" 94" 106" 120" 144" 192"

126F*  25/cs
FASCIA Steel W: 31/32" H: 2 15/32" GOLDTONE WOODTONE 1/4X

48" 60" 72" 96" 106" 120" 144" 192"

1700  25/cs
Steel W: 7/8" H: 13/16" GOLDTONE WOODTONE

24" 30" 32" 36" 48" 60" 72" 96"

1777  25/cs
Aluminum (No wood) W: 1 3/4" H: 11/16"

24" 30" 32" 36" 48" 60"
72" 96" 106" 120" 144" 192"

1825  25/cs
1838 Steel W: 7/8" H: 17/32" WOODTONE WHITE

24" 30" 32" 36" 48" 60" 72" 96"

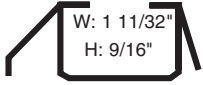
1855*  25/cs
Steel W: 1 11/32" H: 9/16" WOODTONE WHITE

24" 30" 36" 48" 60" 72" 96"

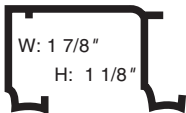
2200  25/cs
Aluminum W: 1 7/8" H: 1 1/8" 1/4X

47" 59" 71" 94" 106" 120" 144" 192"

2200F  25/cs
Aluminum W: 2 13/16" H: 1 5/8" 1/4X

48" 60" 72" 96" 106" 120" 144" 192"

2204F  25/cs
Aluminum W: 1 5/8" H: 1 5/8" 1/4X

48" 60" 72" 96" 106" 120" 144" 192"

2222  with 4-9/16" wood 10/cs without wood 25/cs
Aluminum W: 2 5/35" H: 2 15/16" 1/4X

48" 60" 72" 96" 106" 120" 144" 192"
w/wd
wo/wd

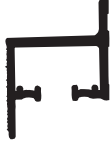
2610F  20/cs
W: 1 1/8" H: 1 3/32" W: 2 5/35" H: 2 15/16"

48" 60" 72" 96" 106" 120" 144" 192"

2800  25/cs
Aluminum W: 1 1/8" H: 1 3/32"

48" 60" 72" 96" 106" 120" 144" 192"

2800F  20/cs
Aluminum W: 2 5/64" H: 1 11/16" 1/4X

48" 60" 72" 96" 106" 120" 144" 192"

2850  25/cs
Steel GOLDTONE W: 7/8" H: 1 1/16"

48" 60" 72" 96" 106" 120" 144" 192"

MERCHANDISER CENTERS

GONDOLA ASSORTMENTS

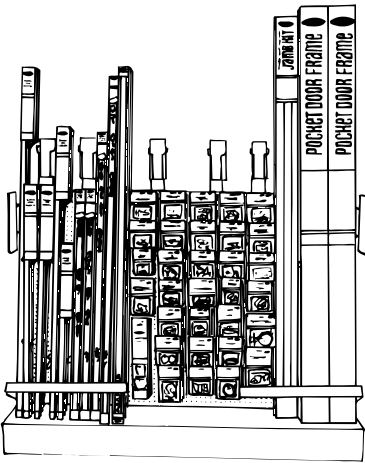

G60

Contains wire grid, vertical aisle header, and DIY literature.

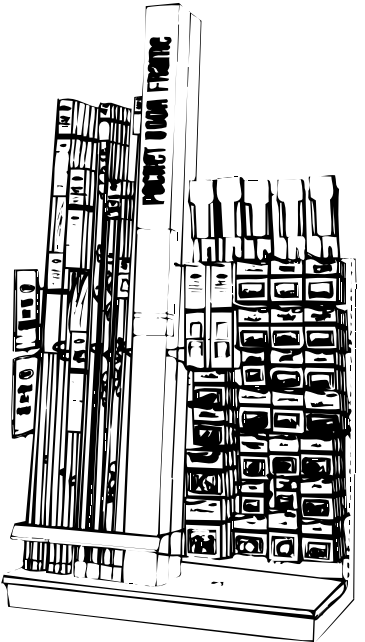

G40 (GONDOLA NOT INCLUDED)

• **G1738 COMBINATION SLIDING-FOLDING DOOR ASSORTMENT**
5-1700363H, 10-1700486H, 5-1700606H, 5-1700726H, 10-1138482D, 5-1138602D, 5-1138722D

• **G2200F SLIDING DOOR ASSORTMENT**
20-2200F481, 10-2200F601, 10-2200F721

• **G9000 CLOSET ROD AND SHELF SUPPORT ASSORTMENT**
10-9018-30P, 20-9030-48P, 10-9048-72P, 5-9072-96P, 5-9072120P, 20-9003WHEN, 20-9005WHEN, 20-9030PPK3

G40 4' MODULAR COMB. SLIDING-FOLDING-POCKET-REPLACEMENT ASSORT. (CONSISTS OF THE FOLLOWING G41 AND G42 2-FT. MODULAR SETS) G40 G40 MINI*

G41 2' COMBINATION SLIDING-FOLDING-POCKET ASSORTMENT G41 G41 MINI*
5-1166G482, 5-1166G602, 5-1166G722, 5-100721DR, 2-153068PF, 5-1700363H, 5-1700486H, 5-1700606H, 5-1700726H

G42 2' ACCESSORY ASSORTMENT G42 G42 MINI*
5-1601218P, 5-2216PPK2, 5-2238PPK2, 5-2136PPK1, 5-1836PPK1, 10-2376PPK2, 10-2378PPK2, 10-2336PPK2, 10-2338PPK2, 10-2135PPK1, 10-1832PPK3, 10-1817PPK3, 10-1808PPK1, 5-1555PPK3, 5-15213PK1, 10-150-3PK1, 5-1500PPK3, 5-1700PPK3, 10-1703PPK2, 10-1805PPK2, 10-15-3PPK3, 10-33-PPK2, 10-2155PPK1, 5-1575PPK3, 10-2312PPK1, 10-1833PPK3

G44* (SAME AS G40 EXCEPT W/2200 ALUMINUM TRACK) G44* G44 MINI*

G45* (SAME AS G41 EXCEPT W/2200 ALUMINUM TRACK) G45* G60
G45 MINI*

G60 6' MODULAR COMB. SLIDING-FOLDING-POCKET-REPLACEMENT ASSORTMENT G60 G60 MINI*
(CONSISTS OF THE FOLLOWING G61, G62 AND G63 2-FT. MODULAR SETS)

G61 2' COMBINATION SLIDING-FOLDING ASSORTMENT G61 G61 MINI*
10-1166G482, 5-1166G602, 5-1166G722, 5-1700363H, 10-1700486H, 5-1700606H, 5-1700726H, 5-100721DR

G62 2' ACCESSORY ASSORTMENT G62 G62 MINI*
5-1601218P, 5-2216PPK2, 5-2238PPK2, 5-2136PPK1, 5-1836PPK1, 10-2376PPK2, 10-2378PPK2, 10-2336PPK2, 10-2338PPK2, 10-2135PPK1, 10-1832PPK3, 10-1817PPK3, 10-1808PPK1, 5-1700PPK3, 10-1703PPK2, 10-1805PPK2, 10-15-3PPK3, 10-30-3PPK2, 10-2155PPK1, 10-2312PPK1, 10-1833PPK3, 10-38-3PPK1, 10-35-3PPK2, 10-40-3PPK3, 10-33-PPK2, 36--PPK2, 10-1823PPK2

G63 2' POCKET DOOR FRAME AND ACCESSORY ASSORTMENT G63 G63 MINI*
4-153068PF, 3-15113068, 10-150-3PK1, 10-1555PPK3, 10-1575PPK3, 5-21-3PPK2, 5-15213PK1, 5-1500PPK3

G64* (SAME AS G60 EXCEPT W/2200 ALUMINUM TRACK) G64

G65* (SAME AS G61 EXCEPT W/2200 ALUMINUM TRACK) G65

WALL-MOUNT

For pegboards, gondolas, etc.



MINI 1601 FULL ACCESS FOLDING DOOR HARDWARE
10-1601218P SETS AND WORKING DISPLAY MODEL

W10 COMBINATION UNIVERSAL SLIDING/FOLDING REPL. PARTS W10 W10 MINI*
5 EA. - 2216, 2238, 2136, 1836 • 10 EA. - 2376, 2378, 2336, 2338, 2135, 1832, 1817, 1808, 2312, 1833





W11 UNIVERSAL SLIDING DOOR REPLACEMENT PARTS
5 EA. - 2216, 2238, 2136, 2156, 2155, 2312, 15-3, 10 EA. - 2376, 2378, 2336, 2338, 2135

W12 UNIVERSAL FOLDING DOOR REPLACEMENT PARTS
5 EA. - 33, 1836 • 10 EA. - 1832, 1817, 1808, 1823, 1703, 1805, 1833

*Mini Assortments include two of each item.

BUBBLE PACKED PARTS AND ACCESSORIES

Attractively packed in see-thru bubbles mounted on colorful hanging cards. Customers see what they are getting – dealers have less pilferage. Some items packed in poly bags.



























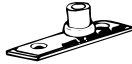





















KNOB - PULLS	CAT. NO	LBS /CT			CAT. NO	LBS /CT	
15 PULL 3/4" ROUND BRASS PLATED STEEL	15-3PPK3	.6 /10	4 Per Pack Pack		33 KNOB 1-3/4" DIA. WOODTONE STYRENE	1.1 /10	2 Per Pack Pr.
20 PULL 1-3/4" ROUND WOODTONE STYRENE	20--PPK2	1 /10	2 Per Pack Pr.		35 PULL 1-3/8" X 3" PLATED STEEL	1.4 /10	2 Per Pack Pr.
21 DUMMY LOCK "SUNCREST" 2-1/8" PLATED STEEL	21-3PPK2 US3 21-5PPK2 US5 21-26DP2 US26D	2 /10	Per Set Pr.		36 KNOB 1-3/4" WOOD (BIRCH)	1.3 /10	2 Per Pack Pr.
30 PULL 2-1/8" PLATED STEEL	30-3PPK2 US3 30-5PPK2 US5 30-26DP2 US26D	1.7 /10	2 Per Pack Pr.		38 KNOB 1-1/2" BRT. BRASS	1.5 /10	1 Per Pack ea.
32 KNOB ACRYLIC ADHESIVE BACKED FOR MIRRORS	32--PPK1	1 /10	1 Per Pack ea.		40 PULL 1-3/8" X 3" PLATED STEEL	1.4 /10	2 Per Pack Pr.
					150 EDGE PULL DIE CAST BRT. BRASS FINISH (SATIN CHROME BULK ONLY SEE PAGE 26)	1.3 /10	1 Per Pack ea.

PARTS AND ACCESSORIES WEIGHT SHOWN / PACKS PER CASE

107 PIV-S PIVOT SET	5.5/10 1 Set/Pak	1575PPK3 1-3/4 ADAPTER KIT	3/10 1 Set/Pak	1832 PPK3 UNIV PIVOT	1.3/10 1 Set/Pak	2226 PPK2 HANGER 1/16" OFFSET	3.5/10 2 Ea./Pak
109 PIV-S PIVOT SET	4/10 1 Set/Bag	1606PPK2 HINGE BRS./BRN.	3.8/10 2 Ea./Pak	1833 PPK3 UNIV SNUBBER	.8/10 1 Set/Pak	2228 PPK2 HANGER 3/8" OFFSET	3.7/10 2 Ea./Pak
118 PIV-S PIVOT SET	2.2/10 1 Set/Bag	1700 PPK3 HDWR.	4.8/10 1 Set/Pak	1836 PPK1 CARPET RISER (Folding Doors)	1.4/10 1 Ea./Pak	2238 PPK2 HANGER 3/8" OFFSET	2.6/10 2 Ea./Pak
119 PIV-S PIVOT SET	4/10 1 ea./Pak	1703 PPK2 HINGE	3.2/10 2 Ea./Pak	1875 PLBG PIVOTS	1.4/10 1 Set/Pak	2255 PPK3 STOP KIT 4 DR.	2/10 1 Set/Bag
209 PIV-S PIVOT SET	1.6/1 1 ea./Pak	1706 PPK3 PIVOTS 1700	1.9/10 1 Set/Pak	1934 PPK3 CUPBOARD HDWR.	1.4/10 1 Set/Pak	2312 PPK1 UNIV. HGR. 7/8" WHL VTRK	3/10 1 Ea./Pak
1120 PPK1 HANGER 1" WHEEL	7/10 1 ea./Pak	1743 PPK2 HINGE	1.3/10 2 Ea./Pak	2006 PLBG WALL MOUNT BRACKET	2.8/10 1 Ea./Pak	2336 PPK2 UNIV. "V" 1/16" OFFSET-3/4" WHL	2/10 2 Ea./Pak
1125 PPK1 BALL BRG.	7/10 1 ea./Pak	1805 PPK2 HINGE	2.4/10 2 Ea./Pak	2050 PLBG CONV DR. KIT	10/10 1 Ea./Pak	2338 PPK2 UNIV. "V" 3/8" OFFSET-3/4" WHL	2/10 2 Ea./Pak
1500PPK3 HDWR. SET	6/10 1 Set/Pak	1806 PPK3 PIVOTS 1825	1.5/10 1 Set/Pak	2135 PPK1 GUIDE	1.3/10 1 Ea./Pak	2376 PPK2 UNIV. "V" 1/16" OFFSET-7/8" WHL	2/10 2 Ea./Pak
1505PPK3 GUIDE/ BUMPER	.7/10 1 Set/Pak	1808 PPK1 ALIGNER	1.2/10 1 Set/Pak	2136 PPK1 CARPET RISER (Sliding Doors)	1.8/10 1 Ea./Pak	2378 PPK2 UNIV. "V" 3/8" OFFSET-7/8" WHL	2.2/10 2 Ea./Pak
1506PPK2 HINGES	2.7/10 2 Ea./Pak	1817 PPK3 BOTTOM PIVOT	2/10 1 Set/Pak	2155 PPK1 BUMPER	.8/10 1 Ea./Pak	2511PPK3 HDWR. SET	6/10 1 Set/Pak
1555PPK3 CONV. DOOR KIT	5/10 1 Set/Pak	1823 PPK2 HINGE	2.3/10 2 Ea./Pak	2156 PPK3 GUIDE/CARPET RISER SET	3/10 1 Set/Pak	2802 PPK2 HANGER	3.7/10 2 Ea./Pak
		1825 PPK3 HDWR.	3.6/10 1 Set/Pak	2216 PPK2 HANGER 1/16" OFFSET	2.5/10 2 Ea./Pak		

BULK PARTS













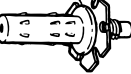







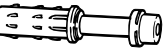





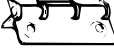









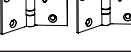







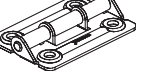

WEIGHT SHOWN IN LBS. FOR PACKAGED QUANTITY

10 GUIDE 	PKG 100 1.7		101 GUIDE 	50 2.3		1603 White 1606 Woodtone HINGE 	50 8.2 50 8.2
11 GUIDE 	100 1.5		150 EDGE PULL Bright Brass Satin Chrome 	25 2		1701 TOP PIVOT 	100 5.4
12 GUIDE 	25 1.1		1001 TOP PIVOT 	25 5		1702 TOP GUIDE 	100 5.5
13 PLUG 	100 1		1010 PIVOT LOCK 	25 8		1703 HINGE 	100 14
14US3 PULL - 2-1/8" Dia. Bright Brass 	100 2.7		1011 FLOOR BRACKET 	25 9		1704 3/4" FLOOR BRACKET 	25 4.2
15US3 PULL - 3/4" Dia. Bright Brass 	100 .7		1020 HANGER 3/4" Wheel 	50 6		1705 GUIDE 	100 5.5
15US26D Satin Chrome 	100 .7		1025 - Ball Bearing 	50 7			
20 PULL - 1-3/4" Dia. Brown Plastic 	50 .8		1021 (1020/1025 Door Plate) 	100 4.5		1706 BOTTOM PIVOT - Long 	100 5.3
21 PULL - 2-1/8" Dia. 3 Finishes Available 	25 1.4		1023 SADDLE BRACKET FOR 1020 HNDR. 	50 3.3		1707 BOTTOM PIVOT 	100 4.8
30 PULL - 2-1/8" Dia. 3 Finishes Available 	100 5.4		1121 (1120/1125 Door Plate) 	100 8		1710 PIVOT LOCK 	50 2.7
32 KNOB Acrylic 	25 1.3		1120 HANGER 1125 1" WHEEL Ball Bearing 	50 12 50 16		1711 JAMB BRACKET 	50 8.2
33 KNOB Brown 	100 3		1155 STOP 	100 3.8		1712 WRENCH 	100 2.5
35 PULL 3 Finishes Available 	50 2.1		1461 BOTTOM PIVOT SOCKET 	50 2.5		1713 SNUBBER 	100 2.6
36 KNOB Wood 	100 3.6		1506 HINGE 	50 5.4		1714 1-1/4" FLOOR BRACKET 	25 5.5
37 KNOB White 	100 3		1513 BUMPER 	100 1		1721 TOP PIVOT 3/4" Doors 	25 3.1
38 KNOB Bright Brass 	100 4.7		1550 GUIDE 	100 2.5		1722 TOP GUIDE 3/4" Doors 	25 3
40 PULL 3 Finishes Available 	50 2.2		1602 White 1605 Woodtone DRYWALL HINGE 	50 10 50 10		1723 BOTTOM PIVOT 3/4" Doors 	25 2.9

All items available in plain poly bags.

BULK PARTS













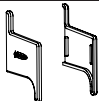



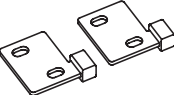







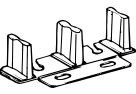

WEIGHT SHOWN IN LBS. FOR PACKAGED QUANTITY

1724 TOP PIVOT 1-1/8" Doors 	25 3.2		1773 BOTTOM PIVOT 3/4" Sidemount 	25 4.2		1837 BOTTOM PIVOT 3/8" Dia. 	100 4.3	
1726 TOP GUIDE 1-1/8" Doors 	25 3.2		1774 BOTTOM GUIDE 3/4" Sidemount 	25 4.6		1861 JAMB BRACKET 	50 2.5	
1727 BOTTOM PIVOT 1-1/8" Doors 	25 3		1775 DOORKEEPER 	25 1.4		1922 TOP GUIDE 3/4" DOORS 	25 3.1	
1728 TOP PIVOT 1-3/8" Doors 	25 3.3		1801 TOP PIVOT/GUIDE 7/16" Dia. 	100 3.6		1926 TOP GUIDE 1-1/8" DOORS 	25 3.5	
1729 TOP GUIDE 1-3/8" Doors 	25 3.3		1804 FLOOR BRACKET 	25 2		1929 TOP GUIDE 1-3/8" DOORS 	25 3.5	
1730 BOTTOM PIVOT 1-3/8" Doors 	25 3.2		1805 HINGE 	100 8.5		1972 TOP GUIDE 3/4" SIDEMOUNT 	25 4.4	
1731 BOTTOM GUIDE 3/4" Doors 	25 3.2		1807 BOTTOM PIVOT 7/16" Dia. 	100 4.4		2001 TOP PIVOT BIFOLD 	25 6	
1732 BOTTOM GUIDE 1-1/8" Doors 	25 3.2		1808 4 DOOR ALIGNER. 	100 7.5		2002 HANGER/GUIDE BIFOLD 	25 23	
1733 BOTTOM GUIDE 1-3/8" Doors 	25 3.4		1810 PIVOT SOCKET 	50 2.8		2003 Ball Bearing Hinge (pairs) US3-US5-US26D 	10 pr. 8.5	
1741 SHUTTER BRACKET 	25 2.6		1811 JAMB BRACKET 	50 5		2007 BOTTOM PIVOT BIFOLD 	25 10	
1742 SHUTTER HANGER 	25 1.1		1812 SNUBBER 2 DOOR 	100 1.2		2010 PIVOT LOCK BIFOLD 	25 10	
1743 SHUTTER HINGE 	100 4.6		1814 SNUBBER 4 DOOR 	100 1.7		2011 FLOOR BRACKET BIFOLD 	25 9	
1744 FLOOR BRACKET 3/4" High Double 	25 8.2		1815 HINGE 	100 8		2020 HANGER BYPASS 	25 29	
1754 FLOOR BRACKET 1-1/4" High Double 	25 11		1823 HINGE (Folding Doors) 	100 9.3		2031 HEAVY DUTY SINGLE GUIDE 	25 6	
1771 TOP PIVOT 3/4" Sidemount 	25 4.3		1831 TOP PIVOT/GUIDE 3/8" Dia. 	100 3.5		2034 GUIDE 1-3/4" 	25 12	
1772 TOP GUIDE 3/4" Sidemount 	25 4.3		1836 CARPET RISER 	25 2.3		2035 GUIDE 1-3/8" 	25 12	

All items available in plain poly bags.

BULK PARTS

WEIGHT SHOWN IN LBS. FOR PACKAGED QUANTITY

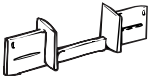
2037 GUIDE 1-3/4"		50 13	2165 STOP		100 4.4	2680 PLBG END CAPS		50 2.3
2038 GUIDE 1-3/8"		50 13	2175 GUIDE 3/4" DOORS		25 1.8	2802 HANGER 7/8" Wheel		50 7.6
2054 PLBG MULTI PULL CATCH		10 1.5	2206 HANGER 1/16" Offset		100 7.1	2812 7/8" Whl. 2815 Ball Brg.		50 12 50 13
2055 TRACK STOP		25 9	2208 HANGER 3/8" Offset		100 100	8050 SWIVEL BRACKET		50 22
2118 NYLON GUIDE 1-1/8" Doors		25 2.2	2216 HANGER 1/16" Offset		100 9.7	9027 1-3/8" ROD SUPPORT		50 8.5
2134 GUIDE 1-1/8" or 1-3/4" Doors		25 2.4	2226 HANGER 1/16" Offset		50 7.4	9028 1" ROD SUPPORT		50 8.2
2135 GUIDE 3/4" or 1-3/8" Doors		100 7.5	2228 HANGER 3/8" Offset		50 8	9029 END BRACKET		50 9.2
2136 CARPET RISER (Sliding Doors)		100 4.8	2238 HANGER 3/8" Offset		100 10.5	9030PLBG POLE CAPS		100 PR 5.8
2138 NYLON GUIDE 1-3/8" Door		100 1.6	2312 UNIV. HNGR V Trk- 7/8" whl.		50 11.2			
2155 STOP		501 1.6	2551 POCKET DOOR GUIDE 1 3/8"		50 1.2			

All items available in plain poly bags.

PRODUCT INDEX



**POCKET DOOR
HARDWARE**



**MULTI-SLIDING DOOR
HARDWARE**



**WALL MOUNT SLIDING
DOOR HARDWARE**



**BI-FOLD DOOR
HARDWARE**



**SLIDING BYPASS DOOR
HARDWARE**



**MULTI-FOLD DOOR
HARDWARE**

LIFETIME GUARANTEE

Johnson Hardware® will replace any item found defective in material or workmanship, regardless of its date of purchase. Send the defective part postage paid to:



L.E. Johnson Products, Inc.
2100 Sterling Avenue
Elkhart, IN 46516

L.E. JOHNSON PRODUCTS, INC.

2100 Sterling Ave. • ELKHART, IN 46516
574-293-5664 • FAX 1-574-294-4697

**Information
800-837-5664**