

# CUSTOM IRON PANELS

ph 800.732.7699 • fax 507.732.7837



www.customiron.com

Custom Iron has created custom panels for stair and balcony railing systems for many years. Now we formally introduce the panel concept to you, our customers.

As a design option, Custom Iron panels create an architectural centerpiece in a section of balustrade. Panels can be easily adjusted during installation – without welding in the field. You can choose from our selection of panel designs, create your own unique panel motif, or you can create your own panel using your choice of balusters and our exclusive Custom Iron Top Bar panel system. See the Top Bar panel information at the end of this section for more details.

Panels are available in 36 and 42" height with smooth or embossed elements. Most panels are suitable for straight, curved, level, or inclined applications. Please inquire about design, material, texture, and finish possibilities.

Custom Iron panels are also suitable for use in our spiral stairs. Panels are another innovative, versatile, easy-to-install design option from Custom Iron.



**Our panels are grouped in Laser and Forged categories and identified by price point and part number. You are welcome to mix panels and balusters of your choice from one price point to another to get the design you want within your budget.**

# LASER PANELS

ph 800.732.7699 • fax 507.732.7837



www.customiron.com

**10700** The **Sanibel Sunrise** shines above the waves in this laser cut panel.

End balusters: 1/2" Square Smooth  
Overall height: 36"  
Overall width: 29 1/16"  
Material: Laser cut steel

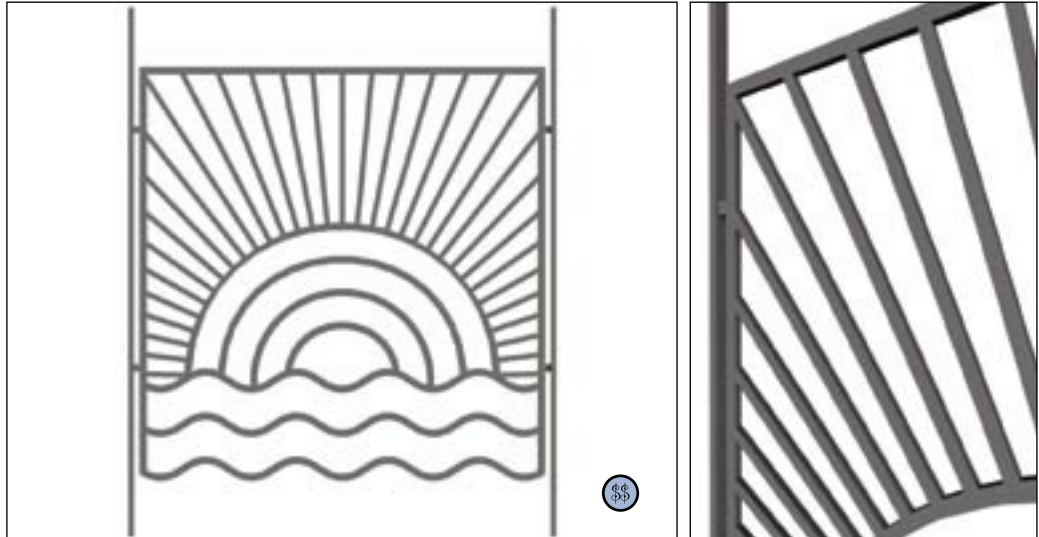

10700 – Sanibel Sunrise panel

**10611** The **Pacific Rim** panel lends an exotic feel to any stair. Although it has a laser cut appearance, this panel is cast aluminum.

End Balusters: 1/2" Square Smooth  
Overall height: 36"  
Overall width: 10 5/8"  
Material: Cast aluminum

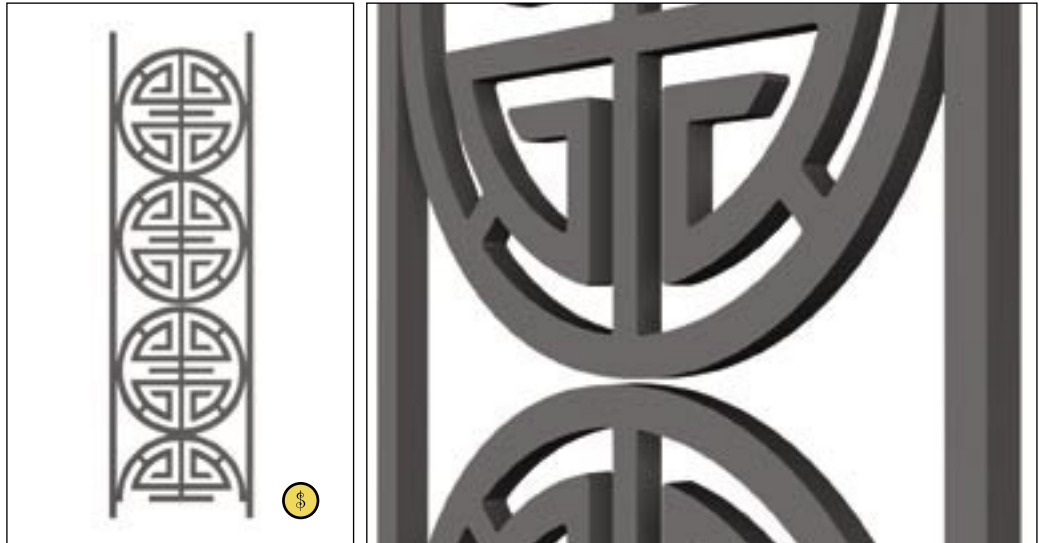

10611 – Pacific Rim panel

**10710** The **Maui Sunburst** has positive energy to burn.

End balusters: 1/2" Square Smooth  
Overall height: 36"  
Overall width: 13 1/16"  
Material: Laser cut steel

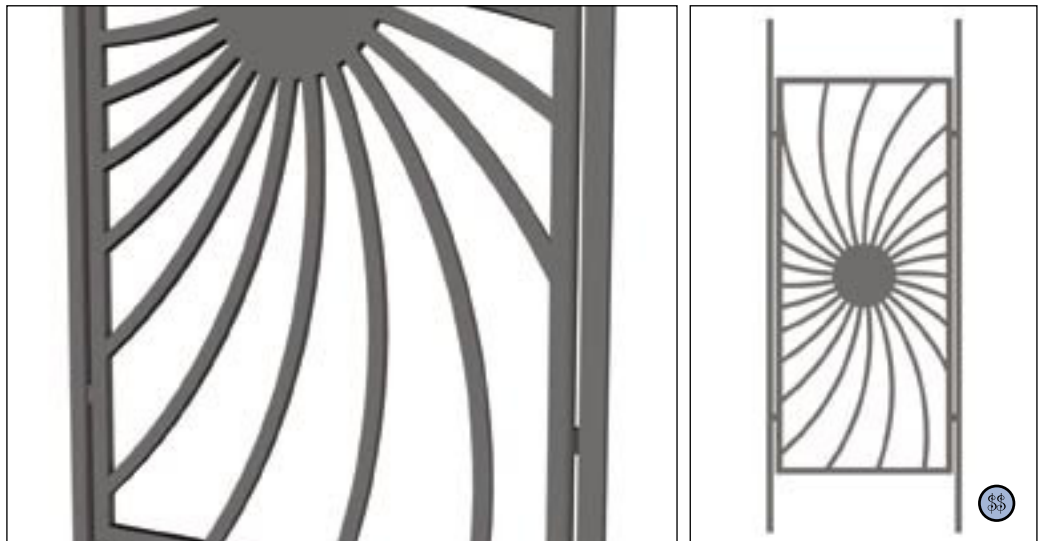

10710 – Maui Sunburst panel



Panels can be used on our spiral stairs. See the Sanibel Sunrise and Maui Sunburst spiral stairs on pages 14 and 15 of the Spirals tab. *All product dimensions are approximate. Availability, designs, and dimensions may vary.*

# LASER PANELS

**10647** The **Two Lilies** panel displays a stylized duet of blooms.

End balusters: 1/2" Square Smooth  
Overall height: 36"  
Overall width: 6 1/2"  
Material: Laser cut steel

**10618** The **Harvest** panel imparts the flavor of nature's bounty.

End Balusters: 1/2" Square on bottom, 1/4" round pegs on top Smooth  
Overall height: 36"  
Overall width: 6 3/4"  
Material: Laser cut steel

**10690** The **Carousel** panel is a playful mix of classic baluster design elements.

End balusters: 1/2" Square Smooth  
Overall height: 36"  
Overall width: 24"  
Material: Forged steel

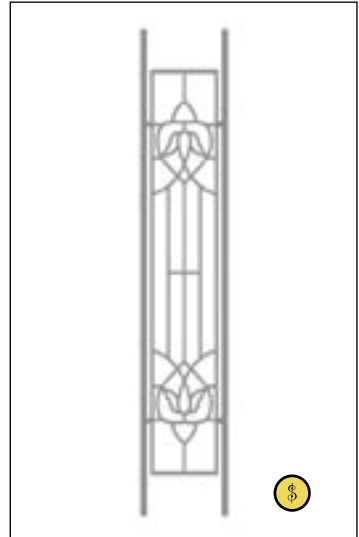
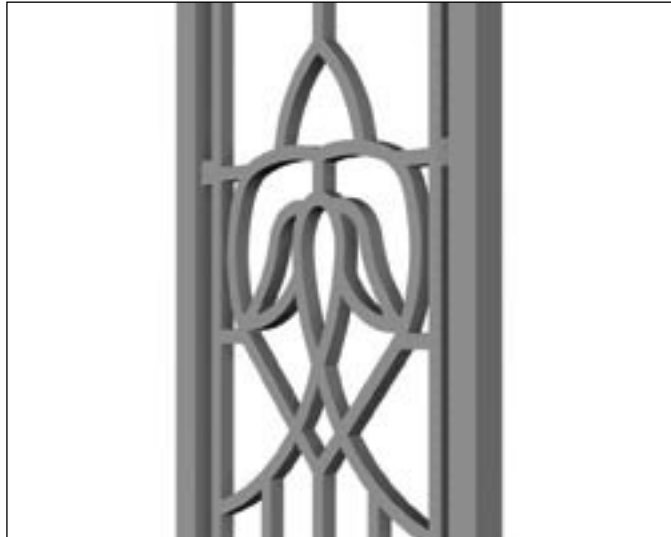

10647 – Two Lilies panel

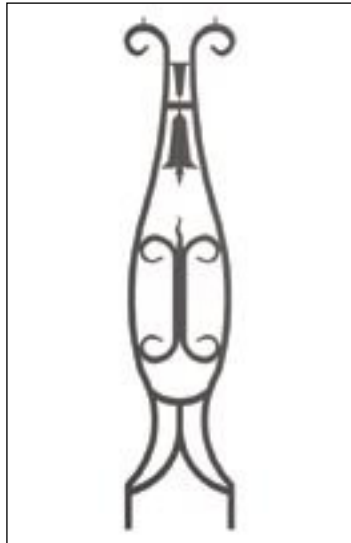

10618 – Harvest panel

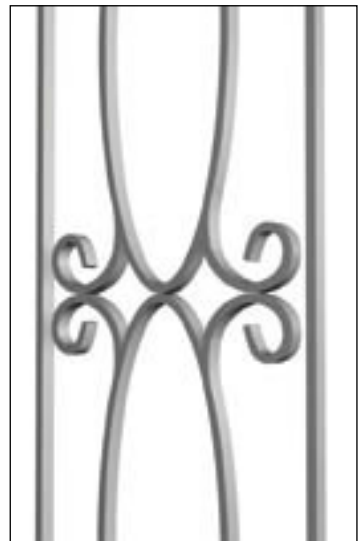
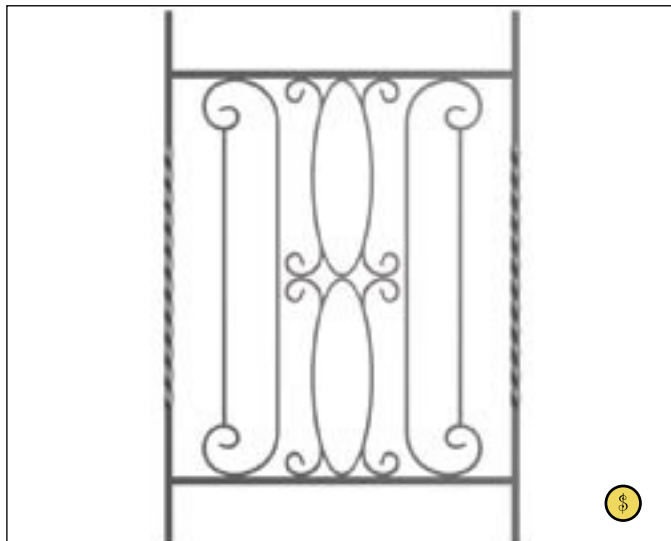

10690 – Carousel panel



Panels are easily installed by inserting the end posts into holes that are drilled into the stair treads.

*All product dimensions are approximate. Availability, designs, and dimensions may vary.*



# FORGED PANELS

ph 800.732.7699 • fax 507.732.7837



www.customiron.com

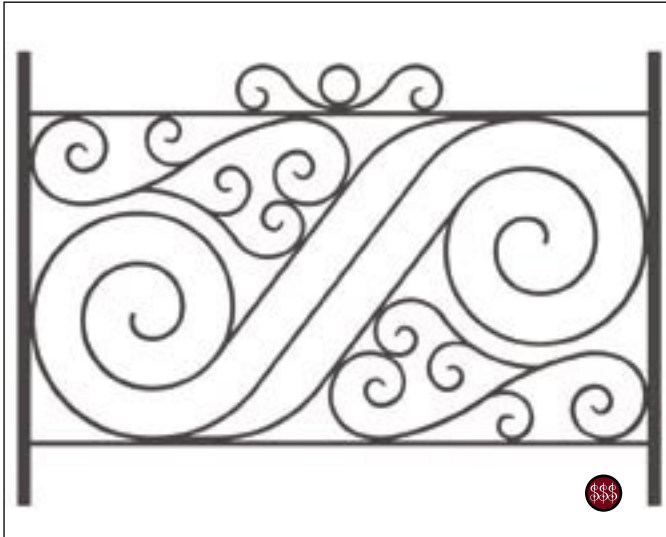

**10670 – Athens Wave**

**10670** The **Athens Wave** panel is inspired by Greek art and architecture with flowing lines and curves.

*Features include: Large scroll wave in center, heart-shaped waves at opposite corners, scrolled panel top.*

End balusters: 1" Square Smooth  
Overall height: 36"  
Overall width: 51"  
Material: Forged steel

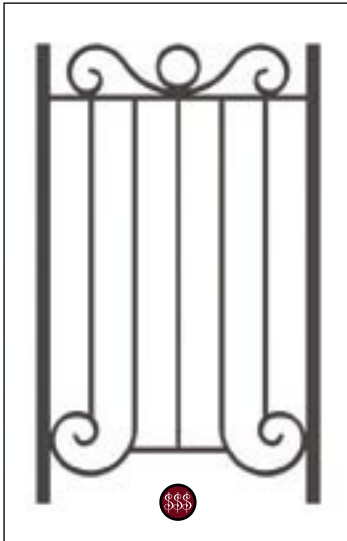

**10671 – Athens Column**

**10671** The **Athens Column** panel retains architectural elements found in the Athens Wave.

End balusters: 1" Square Smooth  
Overall height: 36"  
Overall width: 21"  
Material: Forged steel

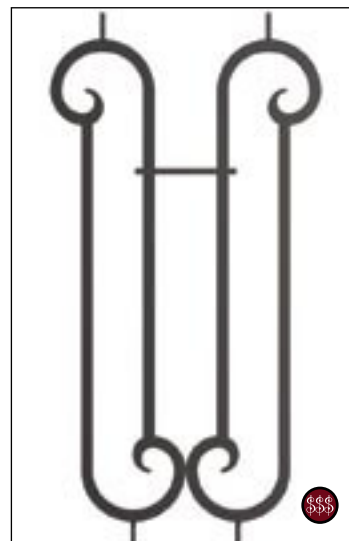

**10615 – Dublin Harp**

**10615** The **Dublin Harp** panel sings with the music found on the Emerald Isle.

*Features include: tapered scrolls at corners, round bar installation ends at top and bottom (instead of square panel end posts).*

See companion balusters 10111 and 10114 on page 9 in the Balusters section.

End pegs: 3/8" Round Smooth  
Overall height: 36"  
Overall width: 17 1/2"  
Material: 3/4" forged steel



Panels can be a dramatic accent to your stair railing. For examples of stair designs using panels, see the Dream it. Build it.™ tab. All product dimensions are approximate. Availability, designs, and dimensions may vary.

# FORGED PANELS

**10660** The **St. Tropez** panel is charmingly scrolled for a French Country feeling. Accents include acanthus leaves and cast rosettes.

End balusters: 1/2" Square Smooth  
 Overall height: 36"  
 Overall width: 40"  
 Material: Forged steel



**10660 – St. Tropez panel**

**10661** The **Chateau** panel's curves and rings make it a friendly companion to the St. Tropez.

End balusters: 1/2" Square Smooth  
 Overall height: 36"  
 Overall width: 16 7/16"  
 Material: Forged steel

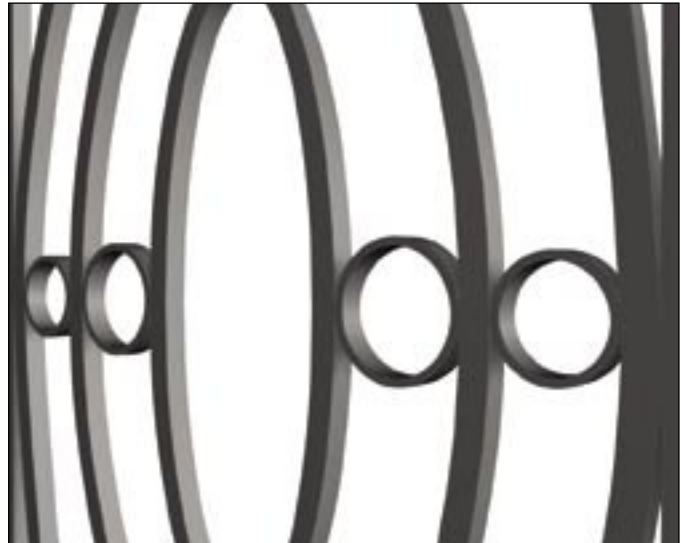
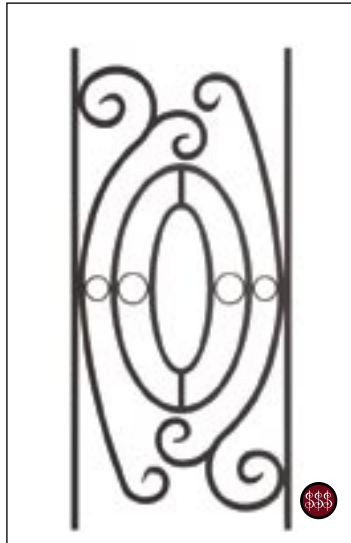

**10661 – Chateau panel**

**10617** The **Whitney Arch** panel curves gracefully at the top to twists on both sides.

*Features include: a 4-bar basket and scrolls at top and bottom, punctuated throughout by steel bands.*

End Balusters: 1/2" Square Chiseled on bottom, 3/8" round peg on top  
 Overall height: 36"  
 Overall width: 8 1/8"  
 Material: Forged steel

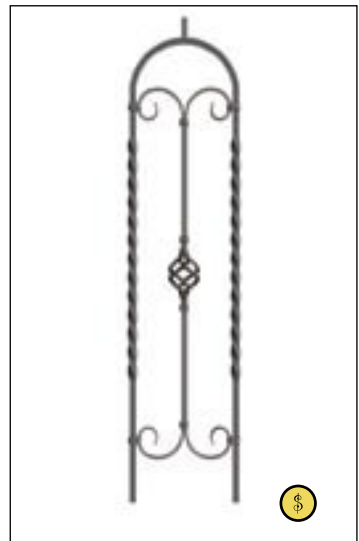

**10617 – Whitney Arch panel**



Most panels can be used on straight, curved, level, or inclined railing systems. Please inquire. *All product dimensions are approximate. Availability, designs, and dimensions may vary.*



# FORGED PANELS

ph 800.732.7699 • fax 507.732.7837



www.customiron.com

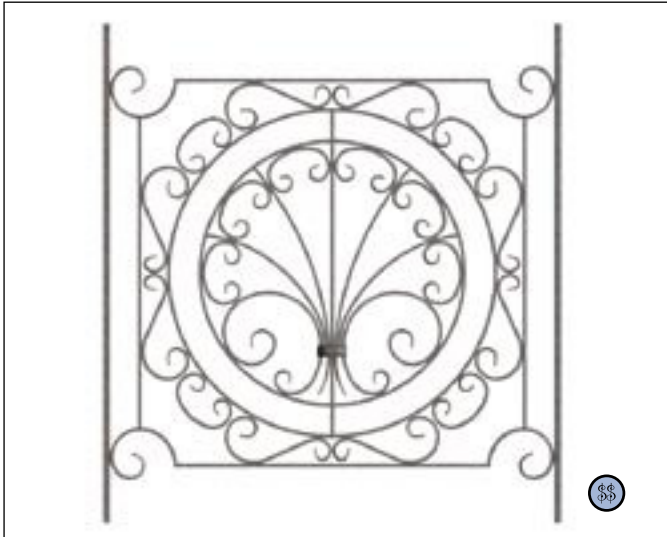

**10650 – Heritage Lace panel**

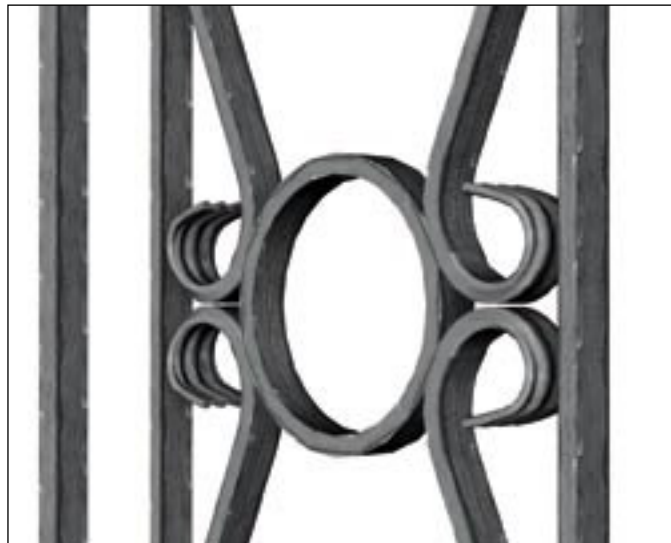
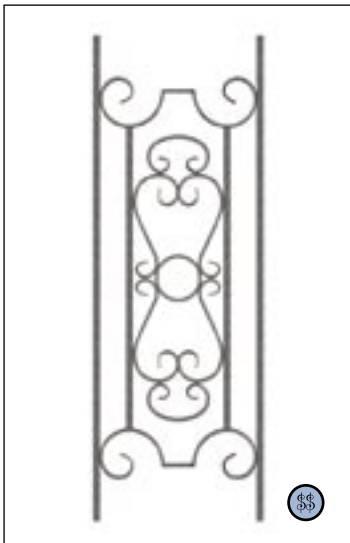

**10652 – Legacy panel**

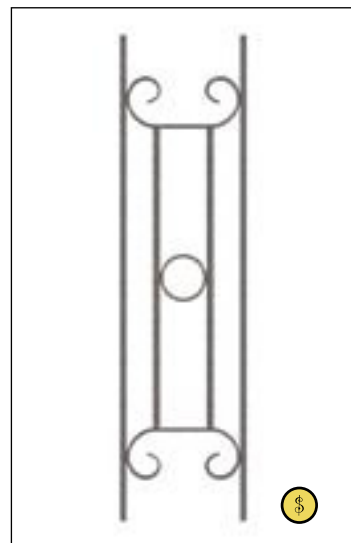

**10651 – Legend panel**

**10650 The Heritage Lace** panel has an intricate pattern reminiscent of fine lacework.

*Features include: banded bouquet of fishtailed scrolls, scrolled top and bottom panel closures.*

End Balusters: ½" Square  
Hammered & Chiseled  
Overall height: 36"  
Overall width: 33"  
Material: Forged steel

**10652 The Legacy** panel inherits the scrolled panel closures from the Heritage Lace panel.

End Balusters: ½" Square  
Hammered & Chiseled  
Overall height: 36"  
Overall width: 12½"  
Material: Forged steel

**10651 The Legend** panel's corner scrolls are related to the Heritage Lace panel, but this simple Legend design could also be translated as a more primitive style.

End Balusters: ½" Square  
Hammered & Chiseled  
Overall height: 36"  
Overall width: 9"  
Material: Forged steel



Panels are available with smooth or embossed elements. Please inquire about material, texture, and finish possibilities. *All product dimensions are approximate. Availability, designs, and dimensions may vary.*

# FORGED PANELS

ph 800.732.7699 • fax 507.732.7837



www.customiron.com

**I0620** The **Spanish Gate** panel delivers old world charm and elegance.

*Features include: fishtail scrollwork with straight fishtail inserts.*

End balusters: 3/4" Square  
Hammered & Chiseled  
Overall height: 36"  
Overall width: 30 1/2"  
Material: Forged steel



**I0620 – Spanish Gate panel**

**I0622** The **Madrid** panel echoes the scroll treatment and centered ring of the Spanish Gate.

End balusters: 3/4" Square  
Hammered & Chiseled  
Overall height: 36"  
Overall width: 13 3/4"  
Material: Forged steel

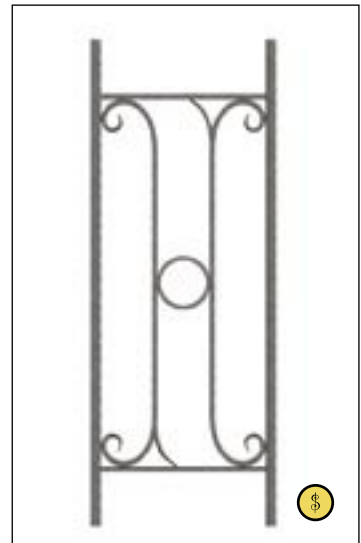

**I0622 – Madrid panel**

**I0621** The **Barcelona** panel is a streamlined complement to more elaborate fishtailed scrollwork.

End Balusters: 3/4" Square  
Hammered & Chiseled  
Overall height: 36"  
Overall width: 9 7/8"  
Material: Forged steel

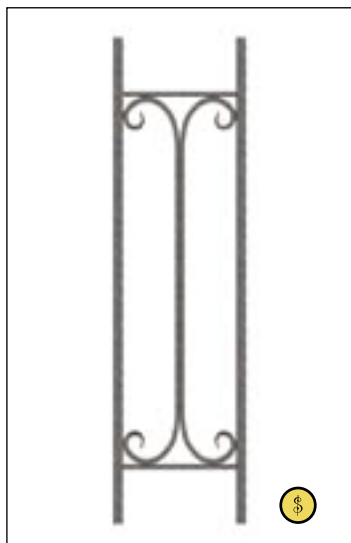

**I0621 – Barcelona panel**



Mix panels with any of our balusters and newels. See the Balusters tab to select complementary balusters and newels for your panels. *All product dimensions are approximate. Availability, designs, and dimensions may vary.*

# FORGED PANELS

ph 800.732.7699 • fax 507.732.7837



www.customiron.com

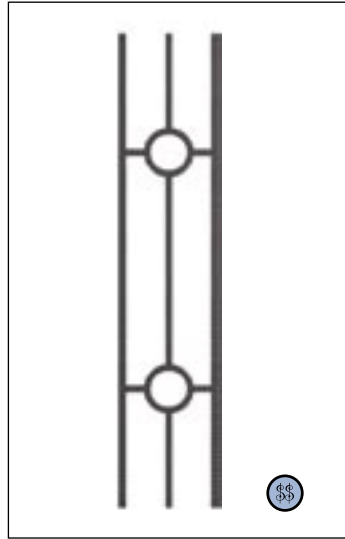

10616 – Totem panel

**10616** The **Totem** panel evokes symbolic images from an ancient past.

End balusters: 1/2" Square  
Face hammered  
Overall height: 42"  
Overall width: 7 1/2"  
Material: Forged steel

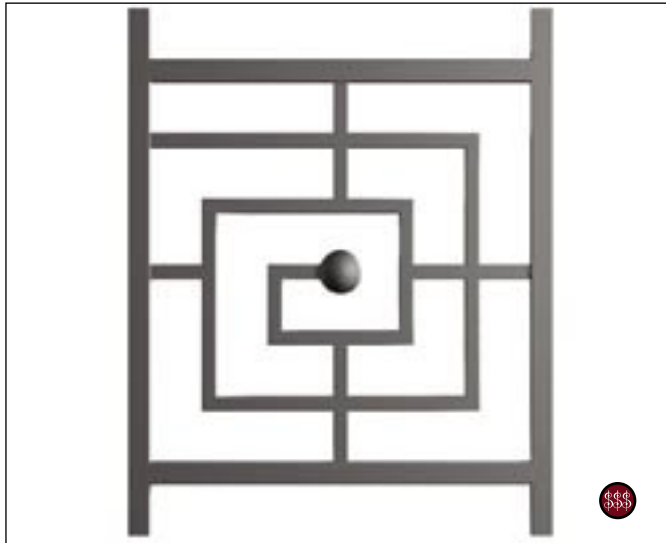

10640 – Maze panel

**10640** The **Maze** panel moves through precise turnings to a sphere at its center.

End balusters: 1 1/2" Square  
Smooth  
Overall height: 36"  
Overall width: 29"  
Material: Forged steel

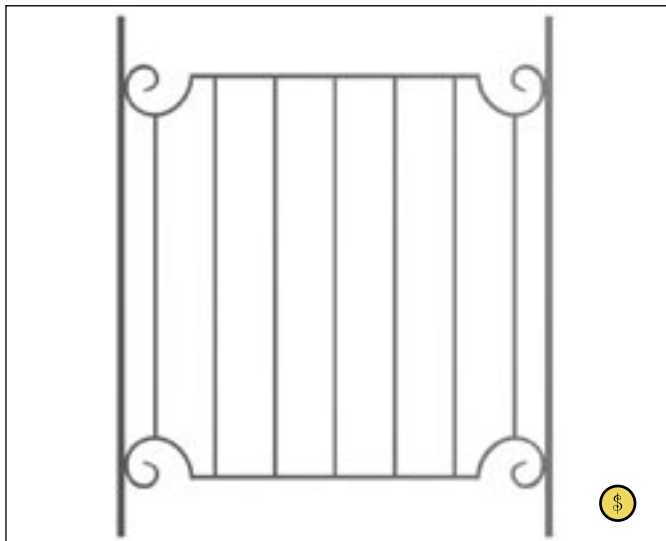
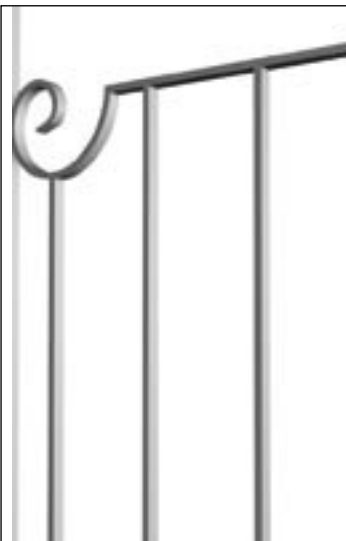

10680 – Dynasty panel

**10680** The **Dynasty** panel, with its simple corner scrolls, has lasting appeal. Note the family resemblance to the Heritage, Legacy, and Legend panels on page 7 of this section.

End Balusters: 1/2" Square  
Smooth  
Overall height: 36"  
Overall width: 30"  
Material: Forged steel



Decorative bases are available for use with panels. See the Options tab for more information. *All product dimensions are approximate. Availability, designs, and dimensions may vary.*



# TOP BAR PANELS

A revolutionary concept in panel design and installation by Custom Iron.

*Simplify installation of any combination of balusters. Easily attach your handrail to a top bar, instead of drilling holes in the handrail to install a group of balusters.*

With the addition of a top bar, a selection of balusters becomes a panel. Installation time is significantly reduced – sometimes by more than half. In a 4-foot section of balustrade, instead of drilling 24 holes for 12 balusters, you could be drilling 2 holes at the bottom and popping in a few rivets to the metal handrail at the top. Alternatively, with a flat top bar, you can screw the panels directly into your wood handrail. Complete installation instructions and templates are provided.

You can easily design either level or incline Top Bar Panels from your selection of balusters. Select an arrangement of balusters. Contact the Custom Iron sales staff and ask them to “Top Bar” those balusters for your stairway or balcony rail specifications.

All Top Bar Panels have a level or incline top bar for quick and easy handrail attachment. Top Bar Panels can also include subrails at the top or bottom of the panel section. The Mountain Meadow panel is an example of one of our Top Bar panel models with both a top and bottom subrail.

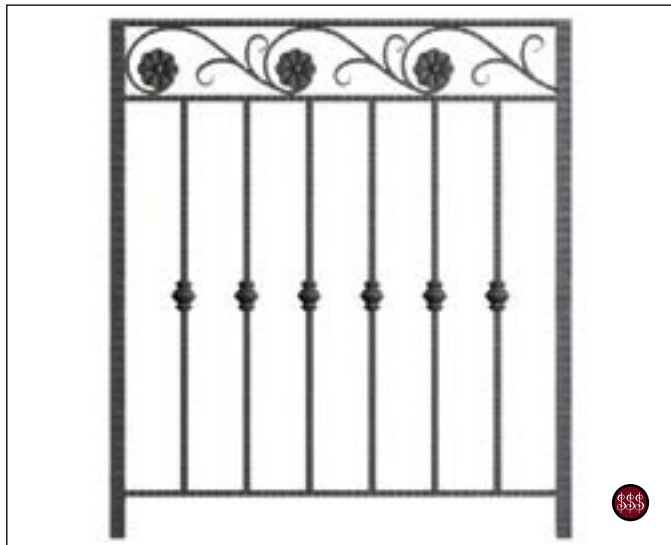
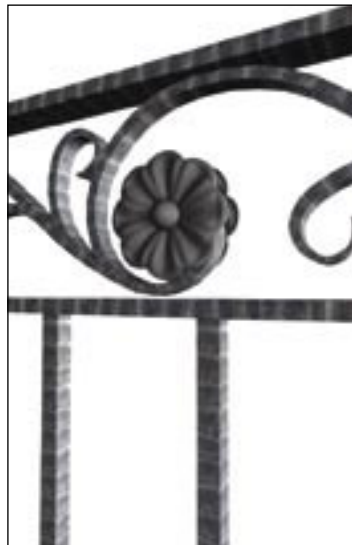
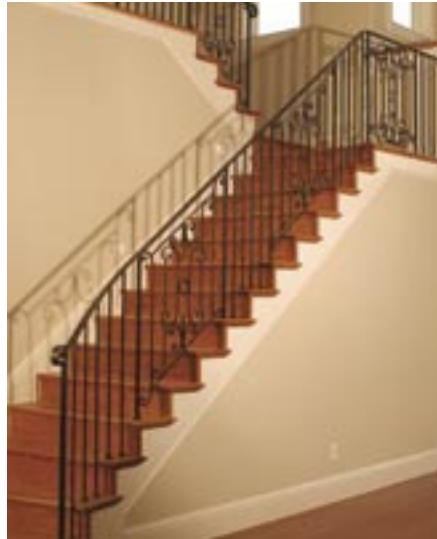

10814 – Mountain Meadow panel

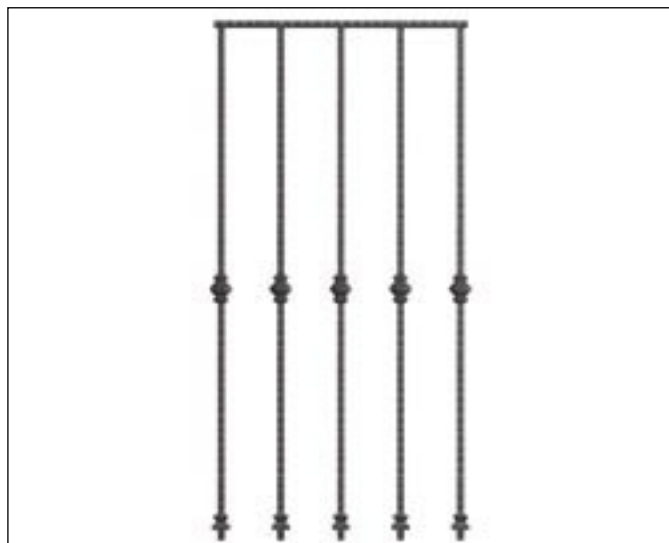

10813 – Prairie Grass panel

**10814 The Mountain Meadow** panel features a floral subrail that breezes along the stairway.

Top Bar end size:  $\frac{3}{8}$ " x 1"  
 End balusters: 1"  
 Face Hammered  
 Overall height: 36"  
 Overall width: 31"  
 Material: Forged steel

**10813 The Prairie Grass** panel completes the view.

End balusters:  $\frac{1}{2}$ "  
 Face Hammered  
 Overall height: 36"  
 Overall width: 18"  
 Material: Forged steel



# TOP BAR PANELS

ph 800.732.7699 • fax 507.732.7837



www.customiron.com

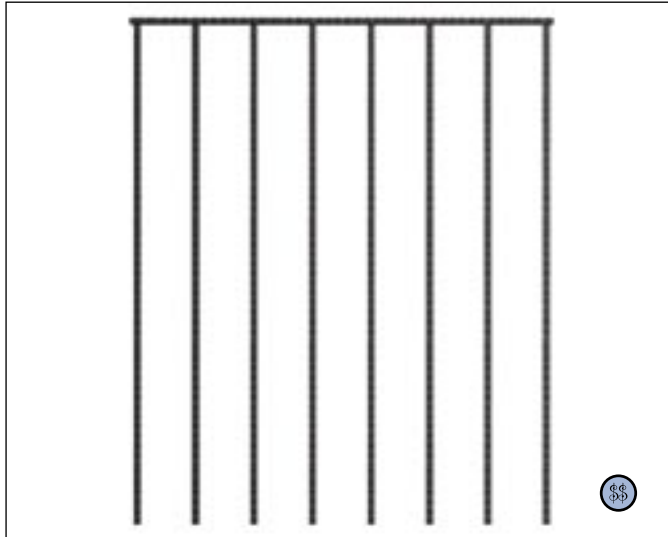

10800 – Rustic 8 Top Bar panel

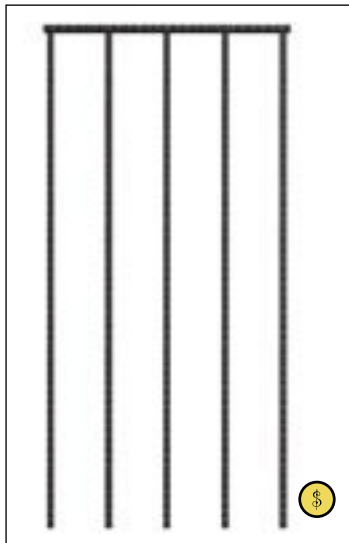
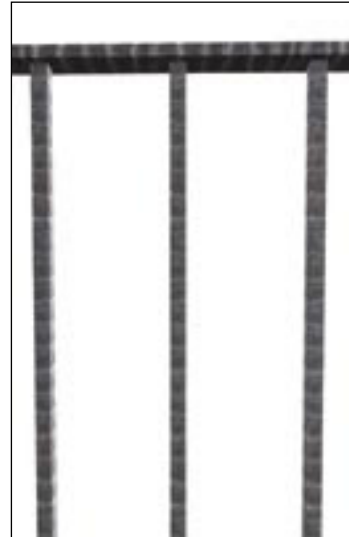

10801 – Rustic 5 Top Bar panel

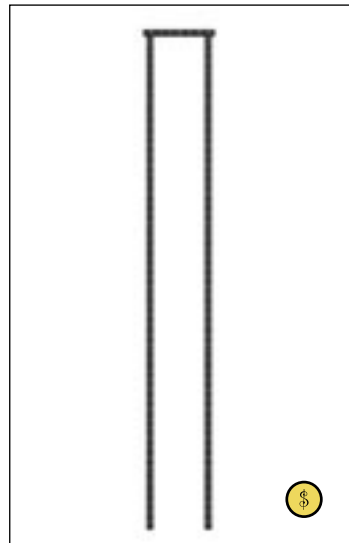

10802 – Rustic 2 Top Bar panel



10204 – Hourglass Top Bar panel

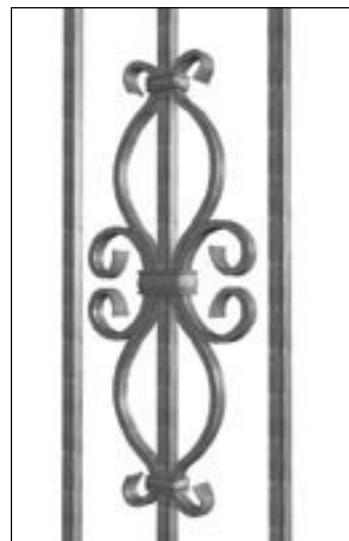

The Rustic Top Bar panel series has a rugged face hammered surface on the top bar and on the balusters. Combinations of eight, five, and two baluster panels work well when creating a stairway installation of Top Bar panels. All Top Bar panels are available for level and incline installations.

### 10800

Top Bar end size:  $\frac{3}{8}$ " x 1"  
End balusters:  $\frac{5}{8}$ " Square  
Face hammered  
Height: 36 & 42"  
Material: Forged steel

### 10801

Top Bar end size:  $\frac{3}{8}$ " x 1"  
End balusters:  $\frac{5}{8}$ " Square  
Face hammered  
Height: 36 & 42"  
Material: Forged steel

### 10802

Top Bar end size:  $\frac{3}{8}$ " x 1"  
End balusters:  $\frac{5}{8}$ " Square  
Face hammered  
Height: 36 & 42"  
Material: Forged steel

### 10204 Hourglass

Top Bar end size:  $\frac{3}{8}$ " x 1"  
End balusters:  $\frac{5}{8}$ " Square, hammered  
Hammered & chiseled scroll and inside balusters  
Overall height: 36"  
Overall width: 26 $\frac{1}{4}$ "  
Material: Forged steel



Remember that you can "Top Bar" any selection of balusters.

# TOP BAR PANEL INSTALLATION



We're the metalsmiths so you don't have to be. Custom Iron panels are designed and engineered so installation time is reduced by up to 50%. Hand-crafted railings, easy installation. Follow these simple steps.

## Check template, mark and drill

**Step 1.** Locate and mark the mounting holes using the templates included with the hardware kit. Each template represents the location of the components within each panel. Check that each template matches the actual panels before drilling the holes. Adjust the space between the templates/panels to accommodate the stair's run specifications.

**Step 2.** After holes are marked correctly, drill the holes. If the hole depth is deeper than the tread thickness, support blocking will be needed to contain the epoxy.

**Step 3.** After holes are marked correctly, drill the holes. If the hole depth is deeper than the tread thickness, support blocking will be needed to contain the epoxy.

## Set primary panels

**Step 4.** Locate the primary panels: top, bottom, level, and any transition panels. Adjust the panels for height and plumb to the handrail. Lock the panel height using the set screws in the bases.

## Add handrail

**Step 5.** Clamp the handrail or a straight edge to the panels and adjust the panel height as needed. It is best to use a stiff expendable material (such as a piece of wood) as a straight edge for this step so the clamps do not damage the handrail, however, in some cases the handrail must be used (i.e. curving stairs). If using a metal handrail, place center panels at this time to prevent the handrail from sagging. DO NOT permanently attach handrail at this time.

## Add epoxy

**Step 6.** Remove the handrail and panels. Add epoxy to the holes and re-insert the panels and handrail. (Epoxy and gun may be purchased from Custom Iron.) The epoxy should start to set within about 7 minutes.

## Attach handrail

**Step 7.** Metal handrail option – Use the commercial drill bit that came with the metal handrail hardware kit to drill through the metal handrail and the top bar of the panels.

**Step 8.** Use rivets included with the metal handrail kit to secure the handrail to the panels. Use a riveting tool (which may be purchased or rented from Custom Iron) to secure the rivets.

**Step 9.** Wood handrail option – Use screws to secure the wood handrail to the panels.

*Simple. Beautiful. Economical. Custom Iron top bar panels...what a concept.*

**Note:** These instructions are meant as a guideline. Your site conditions may dictate variations to these instructions.



Step 1



Step 2



Step 3



Step 4



Step 5



Step 6



Step 7



Step 8

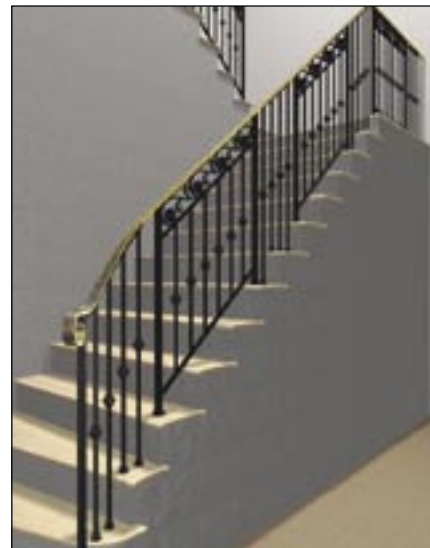

ph 800.732.7699 • fax 507.732.7837



www.customiron.com